



OPERATOR'S MANUAL

MODEL 3400Y BASE UNIT

SERIAL NUMBER 3400Y-AK01001 --





500 Venture Drive
PO Box 148
Orrville Oh 44667
www.ventrac.com

A copy of the parts manual
and this operator's manual
is available at:
<http://ventrac.com/manuals>

View all manuals



To the Owner Contact Information and Product Identification

If you need to contact an authorized Ventrac dealer for information on servicing your product, always provide the product model and serial numbers.

Please fill in the following information for future reference. See the picture(s) below to find the location of the identification numbers. Record them in the spaces provided.

Date of Purchase: _____

Dealer: _____

Dealer Address: _____

Dealer Phone Number: _____

Dealer Fax Number: _____

Model # (A): _____

Serial # (B): _____

Affix Part/Serial Number label here.

Engine Serial # (C) _____

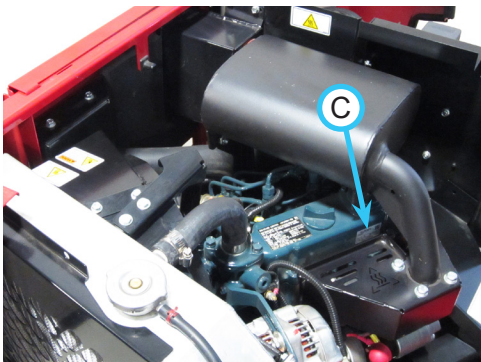

Venture Products Inc. reserves the right to make changes in design or specifications without obligation to make like changes on previously manufactured products.

TABLE OF CONTENTS

INTRODUCTION	PAGE 7
Product Description.....	8
Why Do I Need an Operator’s Manual?	8
Using Your Manual	9
Manual Glossary	9
SAFETY	PAGE 10
Safety Decals	10
General Safety Procedures.....	13
Training Required.....	13
Personal Protective Equipment Requirements	13
Operation Safety	13
Preventing Accidents.....	14
Keep Riders Off.....	14
Operating On Slopes.....	15
Roadway Safety	15
Truck Or Trailer Transport	15
Maintenance.....	16
Fuel Safety	16
Hydraulic Safety	17
3400 Safety Procedures.....	17
Operator Platform Access	17
Roll Over Protective Structure (ROPS).....	18
3400 Safety Procedures.....	18
Operator Safety Interlock System	19
OPERATIONAL CONTROLS	PAGE 20
Standard Operational Control Locations	20
Optional Operational Control Locations	21
RPM/Hour Cluster Gauge (A)	22
Fuel Cluster Gauge (B)	22
Ignition Switch (C)	22
Warning Alarm (D).....	22
Steering Wheel (E).....	23
Steering Tilt Adjustment Lever (F).....	23
Front Hitch Latch Lever (G).....	23
Weight Transfer Select Lever (H).....	23
Circuit Breaker & Battery Disconnect (I)	23
Seat Belt (J)	23
Fuel Shut-off Valve (K)	23
SDLA Control Levers (L & M).....	24
Foot Pedal (N).....	24
Selector Lever/Parking Brake(O)	24
Auxiliary Hydraulic Quick Couplers (P)	25
Power Take Off (PTO) Switch (R)	25
Headlight Switch (S).....	25

TABLE OF CONTENTS

OPERATIONAL CONTROLS (Continued)

Throttle Lever (T)	25
Seat Latch Strap (U)	25
Transmission Neutral Levers (V).....	25
Horn Switch (AA).....	25
Directional Signal Switch (BB)	25
Hazard Flasher Switch (CC)	26
Work Light Switch (DD).....	26
Strobe Light Switch (EE).....	26
12 Volt Rear Switches & 4-Pin Socket (FF, GG, & HH).....	26
12 Volt Front Switches & 4-Pin Socket (RR, SS, & TT)	26
Front Hitch Valve (MM)	26

GENERAL OPERATION

PAGE 27

Daily Inspection.....	27
Starting The Engine	27
Forward And Reverse	28
Stopping The Power Unit	28
Shutting Off The Engine.....	28
Attaching	28
Detaching	29
Operating Attachments.....	29
Front Hitch.....	29
PTO Drive Belt & Pulley	29
Front Auxiliary Couplers	29
Weight Transfer	30
Roll-Over Protection System (ROPS)	30
12 Volt 4-Pin Auxiliary Outlets (Optional Accessory).....	30
Operating On Slopes.....	31
Operation in Water, Mud, Snow, or Ice	31
Towing Or Pushing The Power Unit	31

SERVICE

PAGE 32

Service And General Maintenance.....	32
Cleaning And Appearance Care.....	32
Service Access Points.....	33
Checking Hydraulic Oil Level	34
Changing Hydraulic Oil Filter	35
Changing Hydraulic Oil	35
Changing Rear Transaxle Differential Oil.....	36
Checking Engine RPM	36
Checking Engine Oil Level	37
Changing Engine Oil And Filter	37
Inspecting & Resetting The Air Filter Restriction Gauge	38
Changing Air Filter Elements.....	39
Filling The Fuel Tank	39

TABLE OF CONTENTS

SERVICE (Continued)

Servicing The Fuel Filter/Water Separator	40
Changing The Fuel Filter	40
Priming The Fuel System	40
Checking The Fan (Alternator) Belt	40
Adjusting Fan (Alternator) Belt Tension	41
Cleaning Engine Compartment & Engine	41
Servicing The Cooling System	41
Checking The Cooling System	42
Cleaning The Radiator And Screen	42
Draining The Cooling System	43
Servicing The Battery	44
Removing The Battery	44
Installing The Battery	44
Cleaning The Battery And Terminals	45
Charging The Battery	45
Jump Starting Procedure	45
TCM (Tractor Control Module) Explanation	46
Replacing Fuses (Power Relay Module)	46
Replacing Fuses (Front Fuse Panel)	46
Replacing Fuses (Rear Fuse Panel)	47
Replacing Fuses (Engine)	47
Switching Speedometer (MPH or Km/H)	48
Replacing Light Bulbs (Headlights)	48
Replacing The Taillights	48
Replacing the Work Lights	48
Replacing The Turn Signal Lights	48
Replacing The Strobe Light Bulb	48
Drive Belt Inspection	49
Engine Drive Belt Inspection & Adjustment	49
Engine Drive Belt Replacement	50
PTO Belt Replacement	50
Transaxle Drive Belt Replacement	51
Clutch Air Gap Inspection & Adjustment	52
Wheel Removal & Installation	52
Tire Pressure	52
ROPS And Seat Belt Inspection	53
Parking Brake Inspection & Adjustment	53
Neutral Adjustment	54
Storage	54
Maintenance Schedule	56
Maintenance Checklist	57
Ventrac Maintenance Log	58

TABLE OF CONTENTS

TROUBLESHOOTING	PAGE 61
Wiring Diagram Reference Key.....	61
Wiring Diagram - Rear Harness	62
Wiring Diagram - Front Harness	63
Wiring Diagram Engine Harness.....	64
Wiring Diagram - Optional 30.0219 4-Pin Female Socket & 30.0218 4-Pin Male Plug.....	65
Electrical Troubleshooting Using The Tractor Control Module (TCM).....	66
Electrical Troubleshooting Guide	68
Engine.....	69
Electrical.....	70
Hydraulic	71
Power Unit.....	71
SPECIFICATIONS	PAGE 72
Engine.....	72
Electrical.....	72
Power Train	72
Controls & Instrument Panel	72
Other Features	72
Dimensions	73
Fluid Capacities & Specifications	73
Amperage Draw Chart	74
Belt Chart	74
WARRANTY	PAGE 75

INTRODUCTION



Venture Products Inc. is pleased to provide you with your new Ventrac power unit! We hope that Ventrac equipment will provide you with a ONE Tractor Solution.

Listed below are just some of the items that can provide you *versatility* as you use your 3400. Please visit our web site, or contact your authorized Ventrac dealer for a complete list of items available for your new power unit.

Accessories	Item Description	Part Number
	12 Volt Front Kit	70.3036
	12 Volt Rear Kit	70.3050
	Backup Alarm Kit	70.3037
	Directional / Hazard Signal Kit	70.3046
	ES220 Spreader	39.55500
	Front Hitch Valve Kit	70.3042
	Horn Kit	70.3041
	Rear Weight Bracket Kit	70.3043

Accessories	Item Description	Part Number
	Strobe Light Kit	70.3045
	Suspension Seat	70.3040
	Trailer Mover Hitch	70.2016
	Weather Cab	70.2015
	Work Light Kit	70.3044
	Dual Hydraulic Auxiliary Kit	70.3039

Attachments	Item Description	Part Number
	Aerator with Open Spoon Tine	39.55490
	Aerator with Slitter/Slicer Tine	39.55492
	Aerator with Coring Tine	39.55494
	Blade - 48"	39.55251
	Blade - 60"	39.55252
	Blower	39.35445
	Broom	39.35402
	Edger	39.55330
	Field Mower - 45"	39.35102
	Finish Mower - 52"	39.35100
	Finish Mower - 60"	39.35101

Attachments	Item Description	Part Number
	Rear Discharge Mower - 52"	39.35107
	Power Bucket - 30"	39.55213
	Power Bucket - 48"	39.55214
	Snow Blower	39.35427
	Stump Grinder	39.35300
	Terra Rake - 52"	39.55431
	V-Blade	39.55271

INTRODUCTION

Product Description

The Ventrac 3400 is a unique All Wheel Drive power unit that distributes its power to four equal size flotation tires to provide excellent control, traction, stability, maneuverability, and braking. Its innovative, patented Tandem Drive Train is coupled with an articulating and oscillating, uni-body frame to create a power unit with quiet, efficient, and powerful performance. The 3400 is equipped with power steering and has a turning radius of 28 inches (71 cm), allowing it to maneuver in and around tight places with ease.

The 3400 is designed with the operator seated at the front of the power unit for unobstructed visibility of attachments and terrain ahead. This design uses a rear mounted engine that keeps heat, exhaust, and noise behind the operator.

Ventrac's patented SDLA control, located next to the operator, allows for easy control of Speed, Direction, Lift, and Auxiliary functions with one hand.

The Ventrac attachment mount system allows the operator to change front mounted attachments quickly and efficiently.

Standard features of the 3400 power unit include:

- a fold down roll bar.
- a wire harness that is pre-wired for optional accessories.
- a complete electrical system circuit breaker and battery disconnect.
- a computer controlled onboard diagnostic system for the electrical circuits.
- two cluster gauges on the steering column. One gauge includes a fuel gauge, speedometer, glow plug indicator, parking brake indicator, PTO 'On' indicator, and a low fuel indicator. The second gauge includes an engine temperature gauge, hour meter / tachometer, and warning lights for high engine coolant temperature, low engine oil pressure, and low battery voltage. All of the warning indicator lights also trigger an audible alarm to insure the operator is aware of an unsafe condition.

Why Do I Need an Operator's Manual?

This manual has been created to help you gain the important knowledge of what is needed to safely operate, maintain, and service your machine. It is divided into sections for convenient reference of the appropriate section.

You must read and understand the operator's manual for each piece of Ventrac equipment you own. Reading the operator's manual will help you become familiar with each specific piece of equipment. Understanding the operator's manual will help you, as well as others, avoid personal injury and/or damage to the equipment. Keep this manual with the machine at all times. The manual should remain with the machine even if it is sold. If this manual becomes damaged or unreadable, it should be replaced immediately. Contact your local Ventrac dealer for a replacement.

When using a Ventrac attachment, be sure to read and follow the safety and operating instructions of both the power unit and the attachment being used to ensure the safest operation possible.

The information in this manual provides the operator with the safest procedures to operate the machine while getting the maximum use out of the unit. Failure to follow the safety precautions listed in this manual may result in personal injury and/or damage to the equipment.

INTRODUCTION

Using Your Manual

Throughout this manual, you will encounter special messages and symbols that identify potential safety concerns to help you as well as others avoid personal injury or damage to the equipment.

SYMBOL DEFINITIONS



ATTENTION

This symbol identifies potential health and safety hazards. It marks safety precautions. Your safety and the safety of others is involved.

There are three signal words that describe the level of safety concern: Danger, Warning, and Caution. Safety should always be the #1 priority when working on or operating equipment. Accidents are more likely to occur when proper operating procedures are not followed or inexperienced operators are involved.

Note: Right-Hand and Left-Hand orientations may be referred to at different places throughout this manual. Right-Hand and Left-Hand is determined as if sitting on the power unit seat facing forward.

SIGNAL WORD DEFINITIONS

⚠ DANGER

Indicates an imminently hazardous situation which, if not avoided, will result in death or serious injury. This signal word is limited to the most extreme cases.

⚠ WARNING

Indicates a potentially hazardous situation which, if not avoided, could result in death or serious injury.

⚠ CAUTION

Indicates a potentially hazardous situation which, if not avoided, may result in minor or moderate injury and/or property damage. It may also be used to alert against unsafe practices.

Manual Glossary

- Power Unit** A Ventrac tractor or other Ventrac engine powered device that may be operated by itself or with an attachment or accessory.
- Attachment** A piece of Ventrac equipment that requires a Power Unit for operation.
- Accessory** A device that attaches to a Power Unit or Attachment to extend its capabilities.
- Machine** Describes any "Attachment" or "Accessory" that is used in conjunction with a power unit.

SAFETY

Safety Decals

The following safety decals must be maintained on your Ventrac 3400 power unit.

Keep all safety decals legible. Remove all grease, dirt, and debris from safety decals and instructional labels. If any decals are faded, illegible, or missing, contact your dealer promptly for replacements.

When new components are installed, be sure that current safety decals are affixed to the replacement components.

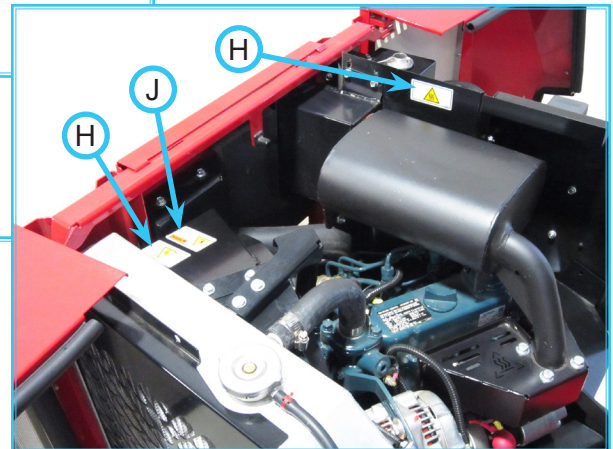

SAFETY

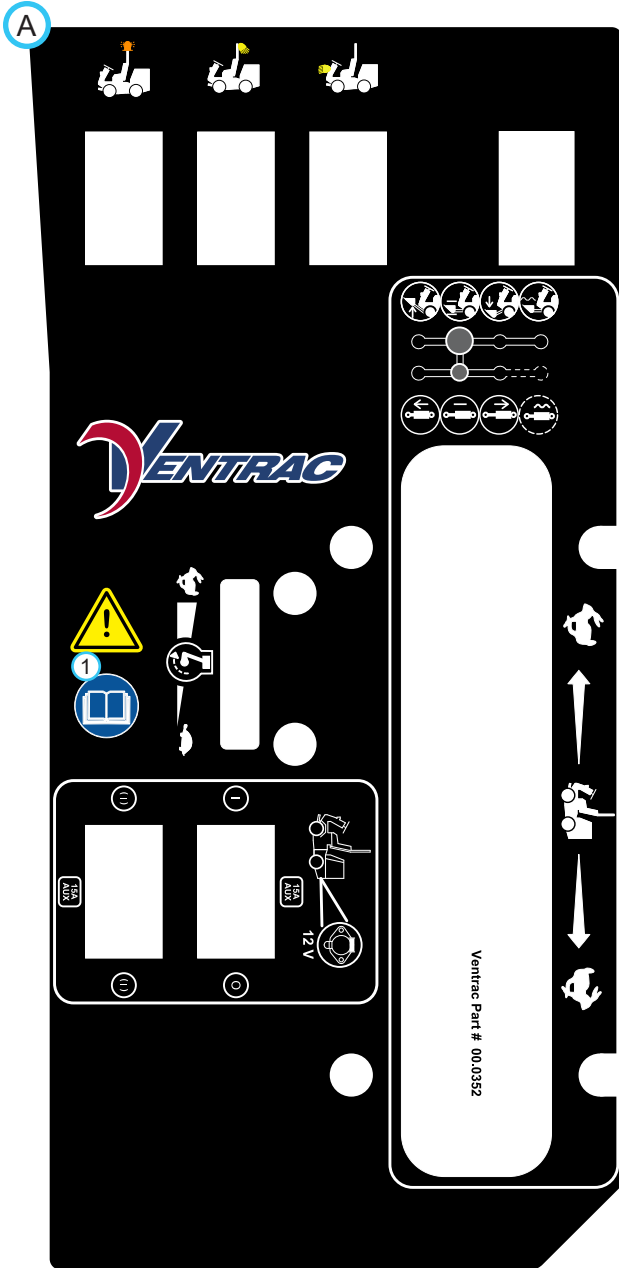

1. WARNING: Read operator's manual.

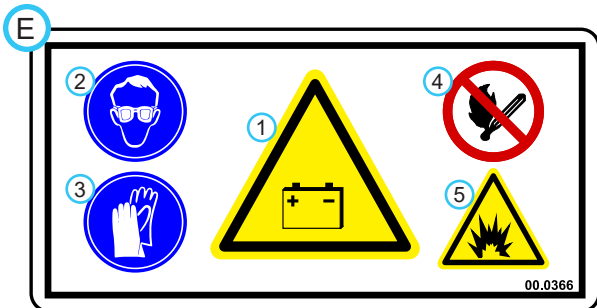

1. DANGER: Battery acid is caustic and can cause chemical burns. Keep bystanders a safe distance from the battery.
2. Wear eye protection, such as goggles or a face shield, when checking or servicing batteries.
3. Wear appropriate protective gear, such as rubber gloves and an apron, when checking or servicing batteries.
4. Do not expose batteries to arcs, sparks, or open flames. Do not use smoking materials near batteries.
5. Explosion hazard - batteries produce flammable and explosive gases.



1. Cutting / entanglement hazard - Stay away from moving parts.

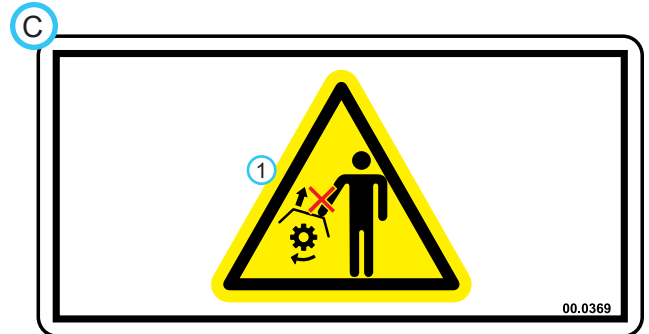

1. Cutting / dismemberment / entanglement hazard - Do not remove shields. Stay away from moving parts.

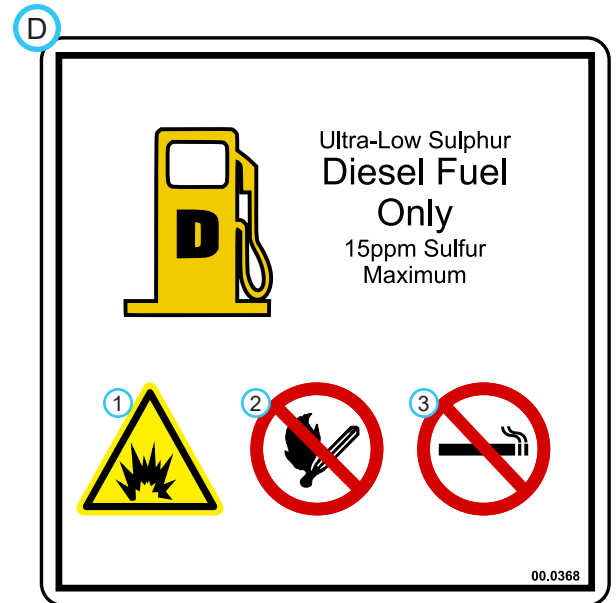

1. DANGER: Explosion / fire hazard.
2. Keep away from fire, sparks, and pilot lights when refueling or storing machine and fuel.
3. Smoking is prohibited.

SAFETY

F



Venture Products, Inc
328 E Water Street
Orville, OH 44667

This ROPS was manufactured by Venture Products Inc. and was tested in accordance with ISO 21299 (ROPS), ISO 3776-2 and ISO 3776-3 (Seat Belt Anchorage).

Vehicle Model: Ventrac 3400
Max GVW: 2200 lbs (1000 kg)

ROPS certification applies only when rollbar is locked in upright position.

Alterations to this structure are not permitted.

If any part of this ROPS experiences structural damage, the entire ROPS must be replaced.

This decal must be kept intact at all times.



00.0360

1. WARNING: Rollover!
2. Keep the roll bar in the raised and locked position and keep the seat belt securely fastened during operation.

G

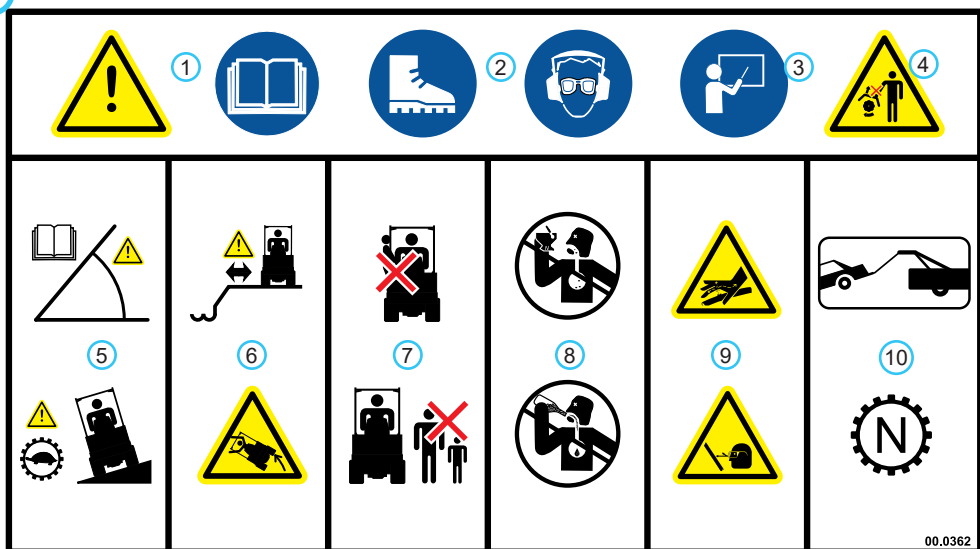

00.0362

1. WARNING: Read operator's manual.
2. Wear personal protective gear, such as safety glasses, closed toe shoes or boots, and ear protection.
3. Operators must receive training prior to operating the machine.
4. Do not operate with shields or guards removed.
5. WARNING: Read slope operation instructions. Slow down when operating on slopes. Keep the roll bar in the raised and locked position and the seat belt securely fastened.
6. WARNING: Keep a safe distance from the edge of drop-offs, ditches, and embankments. The machine could roll over if a wheel drops over the edge or if the edge caves in.
7. Do not carry passengers. Stop the machine if someone enters the area.
8. Do not operate while under the influence of drugs or alcohol.
9. WARNING: Hydraulic fluid is under high pressure and can penetrate skin, causing injury. Keep hands, face, and body away from pinholes or nozzles the eject hydraulic fluid under high pressure.
10. When towing or pushing the power unit, the transaxles must be disengaged by moving the front and rear axle neutral links to the neutral position or damage to the transaxles will result.

H



00.0374

1. Hot surface hazard - Hot surfaces can cause severe burns. Allow engine, exhaust components, and surrounding surfaces to cool before servicing.

J



00.0341

1. Cutting / dismemberment / entanglement hazard - Stay away from moving parts.

Decal	Description	Part Number	Quantity
A	Dash Side	00.0352	1
B	Warning, Moving Parts	00.0365	1
C	Warning, Do Not Remove Shields	00.0369	3
D	Warning, Diesel Only	00.0368	1
E	Warning, Battery	00.0366	1
F	ROPS Certification	00.0360	1
G	Warning, Operator Safety	00.0362	1
H	Warning, Hot Surface	00.0374	2
J	Warning, Fan	00.0341	1

SAFETY



General Safety Procedures for Ventrac Power Units, Attachments, & Accessories



Training Required

- The owner of this machine is solely responsible for properly training the operators.
- The owner/operator is solely responsible for the operation of this machine and prevention of accidents or injuries occurring to him/herself, other people, or property.
- Do not allow operation or service by children or untrained personnel. Local regulations may restrict the age of the operator.
- Before operating this machine, read the operator's manual and understand its contents.
- If the operator of the machine cannot understand this manual, then it is the responsibility of this machine's owner to fully explain the material within this manual to the operator.
- Learn and understand the use of all controls.
- Know how to stop the power unit and all attachments quickly in the event of an emergency.



Personal Protective Equipment Requirements

It is the responsibility of the owner to be sure that the operators use the proper personal protective equipment while operating the machine. Required personal protective equipment includes, but is not limited to, the following list.



- Wear a certified ear protection device to prevent loss of hearing.
- Prevent eye injury by wearing safety glasses while operating the machine.
- Closed toe shoes must be worn at all times.
- Long pants must be worn at all times.
- When operating in dusty conditions, it is recommended that a dust mask be worn.

Operation Safety

- Inspect machine before operation. Repair or replace any damaged, worn, or missing parts. Be sure guards and shields are in proper working condition and are secured in place. Make all necessary adjustments before operating machine.
- Some pictures in this manual may show shields or covers opened or removed in order to clearly illustrate any instructions. Under no circumstance should the machine be operated without these devices in place.
- Alterations or modifications to this machine can reduce safety and could cause damage to the machine. Do not alter safety devices or operate with shields or covers removed.
- Before each use, verify that all controls function properly and inspect all safety devices. Do not operate if controls or safety devices are not in proper working condition.
- Check parking brake function before operating. Repair or adjust parking brake if necessary.
- Observe and follow all safety decals.
- All controls are to be operated from the operator's seat only.
- Always wear a seat belt if the machine has a roll cage/bar installed and in upright position.
- Ensure the attachment or accessory is locked or fastened securely to the power unit before operating.
- Ensure that all bystanders are clear of the power unit and attachment before operating. Stop machine if someone enters your work area.
- Always be alert to what is happening around you, but do not lose focus on the task you are performing. Always look in the direction the machine is moving.
- Look behind and down before backing up to be sure of a clear path.
- If you hit an object, stop and inspect the machine. Make all necessary repairs before operating machine again.
- Stop operation immediately at any sign of equipment failure. An unusual noise can be a warning of equipment failure or a sign that maintenance is required. Make all necessary repairs before operating machine again.

SAFETY



General Safety Procedures for Ventrac Power Units, Attachments, & Accessories



Operation Safety (continued)

- If equipped with a high/low range feature, never shift between high and low range while on a slope. Always move the machine to level ground and engage the parking brake before shifting range.
- Do not leave machine unattended while it is running.
- Always park the machine on level ground.
- Always shut off engine when connecting attachment drive belt to the power unit.
- Never leave the operator's seat without lowering the attachment to the ground, setting the parking brake, shutting off the engine, and removing the ignition key. Make sure all moving parts have come to a complete stop before dismounting.
- Never leave equipment unattended without lowering the attachment to the ground, setting the parking brake, shutting off the engine, and removing the ignition key.
- Only operate in well-lit conditions.
- Do not operate when there is a risk of lightning.
- Never direct the discharge of any attachment in the direction of people, buildings, animals, vehicles, or other objects of value.
- Never discharge material against a wall or obstruction. Material may ricochet back towards the operator.
- Use extra caution when approaching blind corners, shrubs, trees, or other objects that may obscure vision.
- Do not run the engine in a building without adequate ventilation.
- Do not touch the engine or the muffler while the engine is running or immediately after stopping the engine. These areas may be hot enough to cause a burn.
- Do not change the engine governor settings or over-speed the engine. Operating engine at excessive speed may increase the hazard of personal injury.
- To reduce the hazard of fire, keep the battery compartment, engine, and muffler areas free of grass, leaves, and excessive grease.

Preventing Accidents



- Clear working area of objects that might be hit or thrown from machine.
- Keep people and pets out of mowing area.
- Know the work area well before operation. Do not operate where traction or stability is questionable.
- Reduce speed when you are operating over rough ground.
- Equipment can cause serious injury and/or death when improperly used. Before operating, know and understand the operation and safety of the power unit and the attachment being used.

- Do not operate machine if you are not in good physical and mental health, if you will be distracted by personal devices, or are under the influence of any substance which might impair decision, dexterity, or judgment.
- Children are attracted to machine activity. Be aware of children and do not allow them in the working area. Turn off the machine if a child enters the work area.

Keep Riders Off

- Only allow the operator on the power unit. Keep riders off.
- Never allow riders on any attachment or accessory.

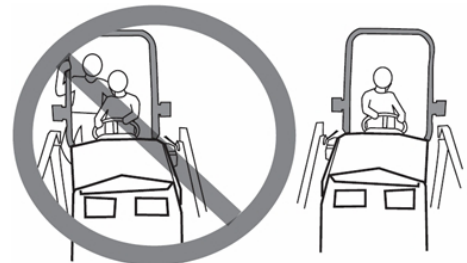

SAFETY



General Safety Procedures for Ventrac Power Units, Attachments, & Accessories



Operating On Slopes

- Slopes can cause loss-of-control and tip-over accidents, which can result in severe injury or death. Be familiar with the emergency parking brake, along with the power unit controls and their functions.
- If power unit is equipped with a fold down roll bar, it must be locked in the upright position when operating on any slope.
- Use low range (if equipped) when operating on slopes greater than 15 degrees.
- Do not stop or start suddenly when operating on slopes.
- Never shift between high and low range while on a slope. Always move the power unit to level ground and engage the parking brake before shifting range or placing the power unit in neutral.
- Variables such as wet surface and loose ground will reduce the degree of safety. Do not drive where machine could lose traction or tip over.
- Keep alert for hidden hazards in the terrain.
- Stay away from drop-offs, ditches, and embankments.
- Sharp turns should be avoided when operating on slopes.
- Pulling loads on hills decreases safety. It is the responsibility of the owner/operator to determine loads that can safely be controlled on slopes.
- Transport machine with attachment lowered or close to the ground to improve stability.
- While operating on slopes, drive in an up and down direction when possible. If turning is necessary while driving across slopes, reduce speed and turn slowly in the downhill direction.
- Assure a sufficient supply of fuel for continuous operation. A minimum of one-half tank of fuel is recommended.

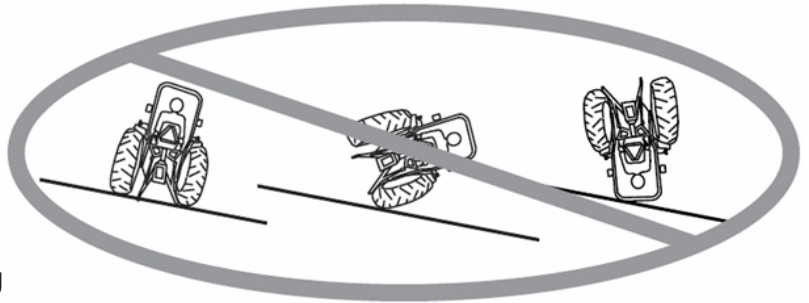

Roadway Safety

- Operate with safety lights when operating on or near roadways.
- Obey all state and local laws concerning operation on roadways.
- Slow down and be careful of traffic when operating near or crossing roadways. Stop before crossing roads or sidewalks. Use care when approaching areas or objects that may obscure vision.
- If there is doubt of safety conditions, discontinue machine operation until a time when operation can be performed safely.
- When operating near or on roadways, have a Slow Moving Vehicle Emblem clearly displayed.

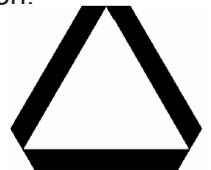

Truck Or Trailer Transport

- Use care when loading or unloading machine into a truck or trailer.
- Use full width ramps for loading machine into a truck or trailer.
- The parking brake is not sufficient to lock the machine during transport. Always secure the power unit and/or attachment to the transporting vehicle securely using straps, chains, cable, or ropes. Both front and rear straps should be directed down and outward from the machine.
- Shut off fuel supply to power unit during transport on truck or trailer.
- If equipped, turn the battery disconnect switch to the Off position to shut off electrical power.

SAFETY



General Safety Procedures for Ventrac Power Units, Attachments, & Accessories



Maintenance

- Keep all safety decals legible. Remove all grease dirt, and debris from safety decals and instructional labels.
- If any decals are faded, illegible, or missing, contact your dealer promptly for replacements.
- When new components are installed, be sure that current safety decals are affixed to the replacement components.
- If any component requires replacement, use only original Ventrac replacement parts.
- Always turn the battery disconnect to the Off position or disconnect the battery before performing any repairs. Disconnect the negative terminal first and the positive terminal last. Reconnect the positive terminal first and the negative terminal last.
- Keep all bolts, nuts, screws, and other fasteners properly tightened.
- Always lower the attachment to the ground, engage parking brake, shut off engine, and remove the ignition key. Make sure all moving parts have come to a complete stop before cleaning, inspection, adjusting or repairing.
- If the power unit, attachment, or accessory requires repairs or adjustments not instructed in the operator's manual, the power unit, attachment, or accessory must be taken to an authorized Ventrac dealer for service.
- Never perform maintenance on the power unit and/or attachment if someone is sitting in the operator's seat.
- Always use protective glasses when handling the battery.
- Check all fuel lines for tightness and wear on a regular basis. Tighten or repair them as needed.
- To reduce the hazard of fire, keep the battery compartment, engine, and muffler areas free of grass, leaves, and excessive grease.
- Do not touch the engine, the muffler, or other exhaust components while the engine is running or immediately after stopping the engine. These areas may be hot enough to cause a burn.
- Allow the engine to cool before storing and do not store near an open flame.
- Do not change the engine governor settings or over-speed the engine. Operating engine at excessive speed may increase the hazard of personal injury.
- Springs may contain stored energy. Use caution when disengaging or removing springs and/or spring loaded components.
- An obstruction or blockage in a drive system or moving/rotating parts may cause a buildup of stored energy. When the obstruction or blockage is removed, the drive system or moving/rotating parts may move suddenly. Do not attempt to remove an obstruction or blockage with your hands. Keep hands, feet, and clothing away from all power-driven parts.
- Dispose of all fluids in accordance with local laws.

Fuel Safety



- To avoid personal injury or property damage, use extreme care in handling gasoline. Gasoline is extremely flammable and the vapors are explosive.
- Do not refuel machine while smoking or at a location near flames or sparks.
- Always refuel the machine outdoors.
- Do not store machine or fuel container indoors where fumes or fuel can reach an open flame, spark, or pilot light.
- Only store fuel in an approved container. Keep out of reach of children.
- Never fill containers inside a vehicle or on a truck or trailer bed with a plastic liner. Always place containers on the ground away from your vehicle before filling.
- Remove machine from the truck or trailer and refuel it on the ground. If this is not possible, refuel the machine using a portable container, rather than from a fuel dispenser nozzle.
- Never remove fuel cap or add fuel with the engine running. Allow engine to cool before refueling.
- Never remove fuel cap while on a slope. Only remove when parked on a level surface.
- Replace all fuel tank and container caps securely.

SAFETY



General Safety Procedures for Ventrac Power Units, Attachments, & Accessories



Fuel Safety (continued)

- Do not overfill fuel tank. Only fill to bottom of fuel neck, do not fill fuel neck full. Overfilling of fuel tank could result in engine flooding, fuel leakage from the tank, and/or damage to the emissions control system.
- If fuel is spilled, do not attempt to start the engine. Move the power unit away from the fuel spill and avoid creating any source of ignition until fuel vapors have dissipated.
- If the fuel tank must be drained, it should be drained outdoors into an approved container.
- Dispose of all fluids in accordance with local laws.
- Check all fuel lines for tightness and wear on a regular basis. Tighten or repair them as needed.
- The fuel system is equipped with a shut-off valve. Shut off the fuel when transporting the machine to and from the job, when parking the machine indoors, or when servicing the fuel system.

Hydraulic Safety

- Make sure all hydraulic connections are tight and all hydraulic hoses and tubes are in good condition. Repair any leaks and replace any damaged or deteriorated hoses or tubes before starting the machine.
- Hydraulic leaks can occur under high pressure. Hydraulic leaks require special care and attention.
- Use a piece of cardboard and a magnifying glass to locate suspected hydraulic leaks.



- Keep body and hands away from pinhole leaks or nozzles that eject high pressure hydraulic fluid. Hydraulic fluid escaping under high pressure can penetrate the skin causing serious injury, leading to severe complications and/or secondary infections if left untreated. If hydraulic fluid is injected into the skin, seek immediate medical attention no matter how minor the injury appears.

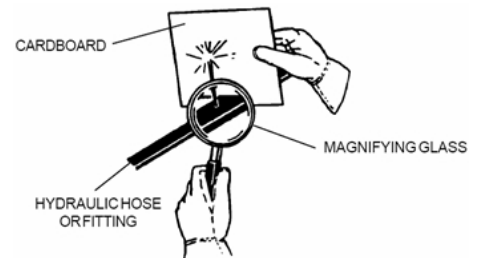

- Hydraulic system may contain stored energy. Before performing maintenance or repairs on the hydraulic system, remove attachments, engage parking brake, disengage weight transfer system (if equipped), shut off engine, and remove ignition key. To relieve pressure on the auxiliary hydraulic system, shut off the power unit engine and move the secondary S.D.L.A. lever left and right before disconnecting the auxiliary hydraulic quick couplers.
- Dispose of all fluids in accordance with local laws.

3400 Safety Procedures

- Power unit hydraulic system may contain stored energy. Before performing maintenance or repairs on the auxiliary hydraulic circuit, remove attachments, engage the park brake, disengage weight transfer system (if equipped), shut off engine, and remove the ignition key.
- Weight transfer spring may contain stored energy. Always disengage the weight transfer system (if equipped) before performing maintenance or repairs on the weight transfer system, the front hitch, or the lift hydraulics.

Operator Platform Access

- The operator platform is to be accessed from the left side of the power unit. Mounting and dismounting the 3400 should only be done from this side.

SAFETY



3400 Safety Procedures



WARNING

The engine exhaust and some of its constituents contain chemicals known to the State of California to cause cancer and birth defects or other reproductive harm.

WARNING

Oils, fuel, and fluids from this power unit as well as waste produced by component wear contain or emit chemicals known to the State of California to cause cancer and birth defects or other reproductive harm.

WARNING

Battery posts, terminals, and related accessories contain lead and lead compounds which are known to the State of California to cause cancer and birth defects or other reproductive harm.

Roll Over Protective Structure (ROPS)

WARNING

Keep the ROPS locked in the upright position and the seat belt securely fastened during operation. Failure to do so could result in serious injury or loss of life.

WARNING

Alterations or modifications to this machine and/or the ROPS structure can reduce safety and could cause damage to the machine. Do not alter the ROPS. Do not alter any other safety devices.

Your power unit is equipped with a Roll-Over Protective Structure (ROPS). This ROPS was tested in accordance with ISO 21299 (ROPS) and ISO 3776-2 and ISO 3776-3 (Seat Belt Anchorage). This ROPS is certified for use on a Ventrac 3400 with a maximum GVW of 2,200 pounds (1,000 Kg).

- ROPS certification applies only when the roll bar is locked in the upright position. Be aware there is no rollover protection when a folding ROPS is in the down position.
- DO NOT remove the ROPS. Alterations to the ROPS structure are not permitted.
- Lower the roll bar only when absolutely necessary and raise the roll bar to the upright position as soon as clearance allows. Never lower a folding ROPS in areas where there are slopes, drop offs, or water.
- Check carefully for overhead clearances (i.e. branches, doorways, electrical wires) before driving under any objects and do not contact them.
- Always wear the seat belt when the roll bar is locked in the upright position. Be certain the seat belt can be released quickly in the event of an emergency.
- Do not wear a seat belt when the roll bar has been lowered to the down position.
- If any part of this ROPS experiences structural damage, the entire ROPS must be replaced.
- Inspect the seat belt for wear or damage before use. Failure to inspect or maintain the seat belt can cause injury or loss of life.

SAFETY



3400 Safety Procedures



Operator Safety Interlock System

The 3400 power unit is equipped with a safety interlock system. This system:

- Prevents the engine from starting unless the parking brake is engaged.
- Prevents the PTO from starting if the operator is not in the seat.
- Prevents the power unit from driving if the parking brake is engaged.
- Shuts off the PTO if the operator leaves the seat.
- Shuts off the engine (and fuel pump) if the operator leaves the seat without engaging the parking brake.

Testing the Safety Interlock System

WARNING

Never operate the power unit if the safety interlock system is malfunctioning. Do not disengage or bypass any switch. Failure to heed warning could result in injury to yourself and others, or damage to property.

CAUTION

The daily inspection should be performed prior to initial startup for the day.

Perform the following safety interlock tests daily. Before testing, park the power unit on a level surface, place wheel chocks in front and back of wheels, and place the high/low range shift lever in the neutral position. After testing is complete, place the high/low shift lever in either high or low range, set the parking brake, and remove the wheel chocks.

Tests 1-3 test the 'Engine Start' function. For each test, turn the key to the RUN position (do not start the engine). As listed for each test, engage or disengage the parking brake and sit on the seat or raise body weight from seat. The engine starter should or should not engage as described for each test.

Tests 4-6 test the 'Engine Run' function. For each test, start the power unit so that the engine is running. As listed for each test, engage or disengage the parking brake and sit on the seat or raise body weight from seat. The engine should continue running or stop running as described for each test.

Tests 7-10 test the 'PTO' function. For each test, turn the key to the RUN position (do not start the engine). As listed for each test, place the PTO switch in the ON or OFF position and sit on the seat or raise body weight from seat. The electric PTO clutch will make an audible noise when it engages or disengages.

Engine Start	Test Number	Parking Brake Engaged	Operator Present in Seat	Engine Starts
	1	No	Yes	No
	2	Yes	No	Yes
	3	Yes	Yes	Yes
Engine Run	Test Number	Parking Brake Engaged	Operator Present in Seat	Engine Runs
	4	Yes	Yes	Yes
	5	Yes	No	Yes
	6	No	No	No
PTO	Test Number	PTO Switch	Operator Present in Seat	PTO Clutch
	7	Off	Yes	Off
	8	Pull to 'On' Position	No	No
	9	Pull to 'On' Position	Yes	Yes
	10	On	Raise Operator Body Weight from Seat	PTO Disengages <small>(1/2 second delay)</small>

If the power unit fails any one of the safety interlock tests, refer to the troubleshooting section for using the TCM (tractor control module) to diagnose electrical problems.

OPERATIONAL CONTROLS

Standard Operational Control Locations

Use the following images to help identify the locations of operational controls. The letter next to each control can be referenced to the list that follows these images.

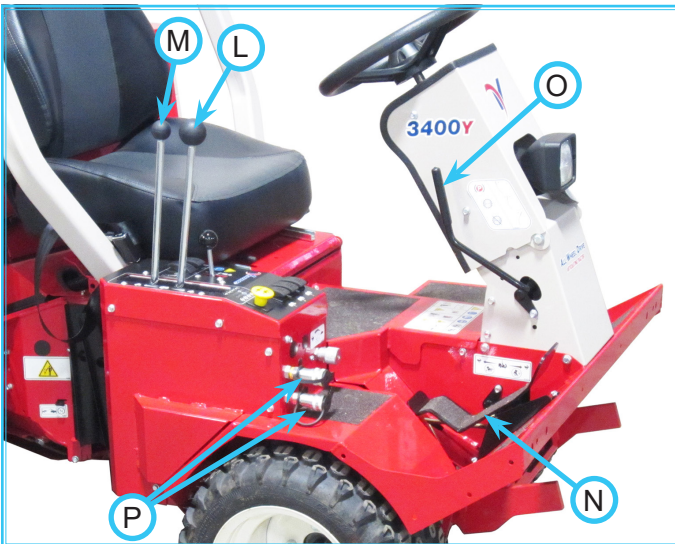
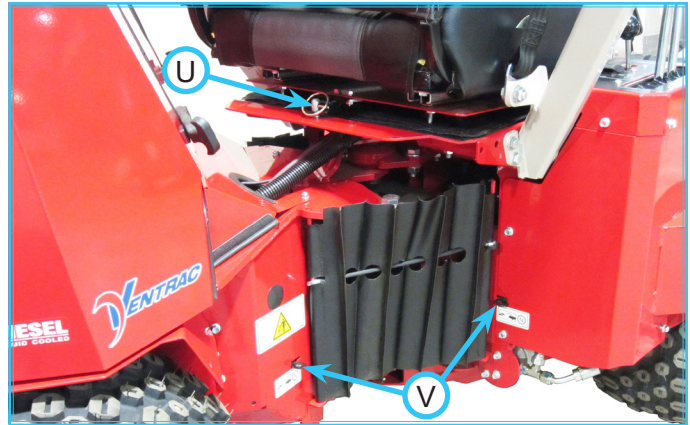
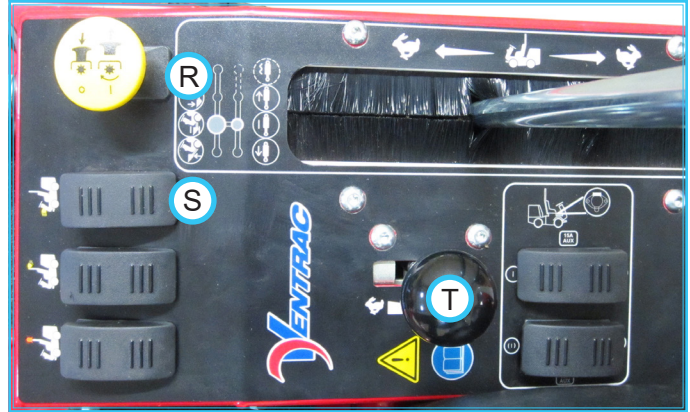

- A. RPM/Hour Cluster Gauge
- B. Fuel Cluster Gauge
- C. Ignition Switch
- D. Warning Alarm (Continuous)
- E. Steering Wheel
- F. Steering Tilt Adjustment Lever
- G. Front Hitch Latch Lever
- H. Weight Transfer Select Lever
- I. Circuit Breaker & Battery Disconnect
- J. Seat Belt
- K. Fuel Shut-off Valve
- L. Primary SDLA Control Lever
- M. Secondary SDLA Control Lever
- N. Foot Pedal
- O. Selector Lever/Parking Brake
- P. Auxiliary Hydraulic Quick Couplers
- R. PTO Switch
- S. Headlight Switch
- T. Throttle Lever
- U. Seat Latch Strap
- V. Transaxle Neutral Levers

OPERATIONAL CONTROLS

Optional Operational Control Locations

Use the following images to help identify the locations of operational controls for optional kits. The letter next to each control can be referenced to the list that follows these images.

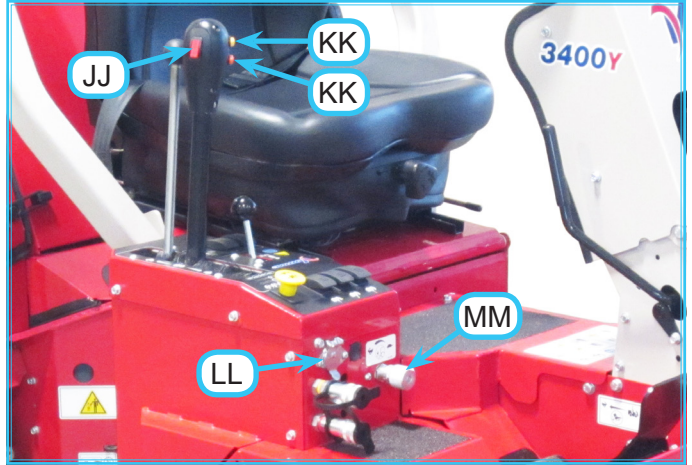

- AA. Horn Switch
- BB. Directional Signal Switch
- CC. Hazard Flasher Switch
- DD. Work Light Switch
- EE. Strobe Light Switch
- FF. Rear 12V Switch (On/Off)
- GG. Rear 12V Switch (Momentary On/Off/On)
- HH. Rear 12V 4-Pin Socket
- II. Back Up Alarm
- JJ. Front 12V Switch (On/Off)
- KK. Front 12V Buttons (Momentary On)
- LL. Front 12V 4-Pin Socket
- MM. Front Hitch Valve

OPERATIONAL CONTROLS

RPM/Hour Cluster Gauge (A)

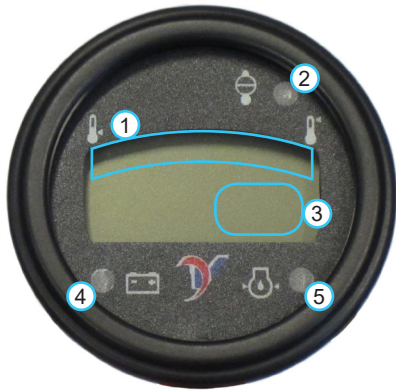

1. Water Temperature Gauge
2. Water High Temperature Warning Light
3. Tachometer / Hour Meter
4. Low Voltage Warning Light
5. Low Engine Oil Pressure Warning Light

The **water temperature gauge** displays the temperature of the engine cooling system.

The **water high temperature warning light** and audible alarm activate when the temperature of the engine cooling system reaches unsafe levels. If this light and alarm comes on during operation, park the power unit, turn the PTO off, reduce engine speed to low idle, and allow the engine to cool. Check the radiator screen and clean, if necessary. If engine temperature continues to rise, shut off the engine. If the engine continually overheats, refer to the troubleshooting section for possible problems.

The **tachometer / hour meter** displays both the engine run time and the engine speed. When the engine is not running and the ignition switch is turned to the On position, the gauge displays the accumulated time the ignition key has been switched to the On position. When the engine is running, the gauge displays the engine speed in RPM.

The **low voltage warning light** and audible alarm activate when the voltage drops to unacceptable levels. If this light and alarm comes on, shut off any unnecessary lights and accessories to reduce current draw. If voltage continues to drop, park the power unit, shut off the engine, and turn the ignition key to the off position. Refer to the troubleshooting section for possible problems.

The **low engine oil pressure warning light** and audible alarm activate when the engine oil pressure is below safe levels. The light comes on when the ignition key is switched to the on position and stays illuminated until the engine is started and safe oil pressure develops. If this light and alarm comes on during operation, immediately shut off the engine. Do not restart the engine until the problem has been located and corrected.

Fuel Cluster Gauge (B)

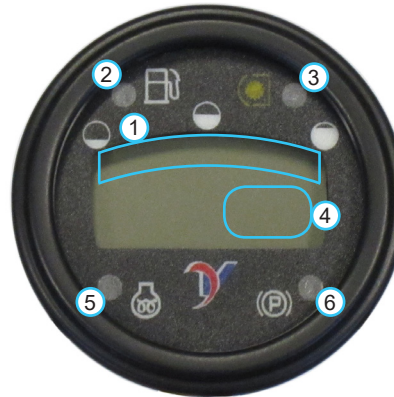

1. Fuel Gauge
2. Low Fuel Warning Light
3. PTO Indicator Light
4. Speedometer
5. Glow Plug Indicator Light
6. Park Brake Indicator Light

The **fuel gauge** displays the level of fuel in the tank. The **low fuel warning light** activates when the fuel level is low.

The **PTO indicator light** activates when the power unit's PTO clutch is engaged.

The **speedometer** displays the speed of the power unit. The speedometer can be set to display either miles per hour (mph) or kilometers per hour (kph).

The **glow plug indicator light** indicates activation of the glow plugs for preheating the engine. The glow plugs activate when the key is turned to the on position. When the glow plug light turns off, the engine is ready to start.

The **park brake indicator light** activates when the park brake is set.

Ignition Switch (C)

1. Off or Stop Position - all 12 volt power going through the key switch is off.
2. On or Run Position - engine run position, 12 volt power is sent to accessories.
3. Start Position - when the key is turned to the start position, the starter will engage.

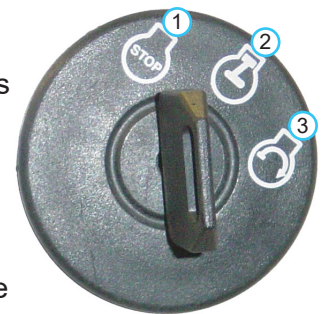

Warning Alarm (D)

The warning alarm works with the RPM/Hour cluster gauge to alert the operator to problems. The warning alarm sounds a continuous signal whenever a warning is displayed on the RPM/Hour cluster gauge. If the warning alarm sounds, immediately check the RPM/Hour cluster gauge to determine the cause of the warning and then take appropriate action.

OPERATIONAL CONTROLS

Steering Wheel (E)

Turn the steering wheel to the left (counterclockwise) to turn the power unit to the left. Turn the wheel to the right (clockwise) to turn the power unit to the right.

Steering Tilt Adjustment Lever (F)

Push down on the steering tilt adjustment lever to release the adjustment lock. Tilt the steering column forward or backward to the desired position. Release the steering tilt adjustment lever to lock the steering column in place.

Front Hitch Latch Lever (G)

The front hitch latch lever 1. Unlocked locks or unlocks the hitch 2. Locked latch.

Rotate the front hitch latch lever toward the front of the power unit to unlock the hitch latch when attaching or detaching Ventrac attachments.

Rotate the front hitch latch lever toward the rear of the power unit to lock the hitch latch over the hitch arm pins on Ventrac attachments. Ensure the lever is secured in the frame notch and the front hitch lever lock is in place.

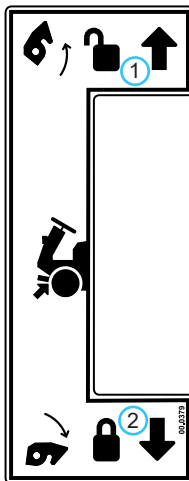

Weight Transfer Select Lever (H)

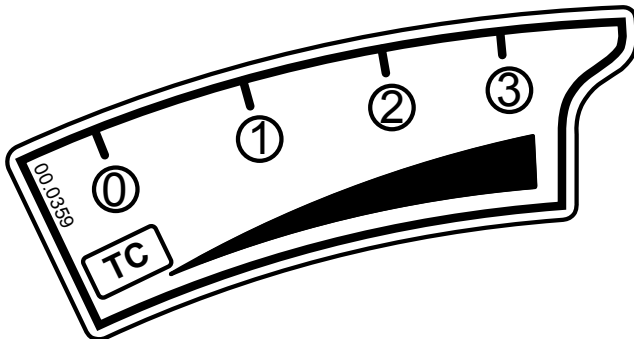

The weight transfer system transfers weight from the attachment to the front wheels of the power unit. Transferring weight from the attachment to the power unit increases the traction control, improves hillside maneuverability, aids in lifting the attachment, reduces steering effort, and lessens the attachment resistance when in contact with the ground.

The operator can select different transfer rates by selecting one of the four positions from no weight transfer (0) to maximum weight transfer (3). Set the weight transfer to 0 when attaching or detaching any attachment.

Circuit Breaker & Battery Disconnect (I)

The circuit breaker/battery disconnect switch controls power to the entire electrical system. Turning the switch to position 0 disables the electrical system, allowing electrical components to be serviced.

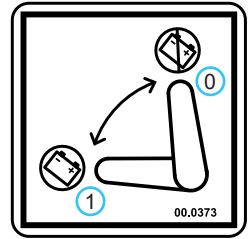

- 0. Electrical Power Off
- 1. Electrical Power On

Seat Belt (J)

Sit down on the seat and adjust the seat to the desired position. Pull the seat belt across your lap, ensure the seat belt is not twisted, and insert the belt latch plate into the seat belt buckle until it clicks. Pull up on the latch plate to make sure it is secure. Pull on the loose end of the seat belt to snug the seat belt across your lap.

Fuel Shut-off Valve (K)

The fuel shut-off valve controls the flow of fuel to the power unit engine. Turning the valve to position 1 will allow fuel to flow to the engine.

Turning the valve to position 0 shuts off the fuel flow to prevent fuel leakage when changing fuel filters or servicing the fuel system. Turn off the fuel shut-off valve when transporting the power unit on a truck or trailer and when parking the power unit indoors.

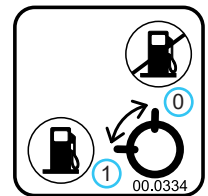

- 0. Fuel Off
- 1. Fuel On

OPERATIONAL CONTROLS

SDLA Control Levers (L & M)

1. Forward Direction
2. Reverse Direction
3. Lift
4. Hold
5. Lower
6. Float
7. Direction #1
8. Hold
9. Direction #2
10. Float (if equipped)

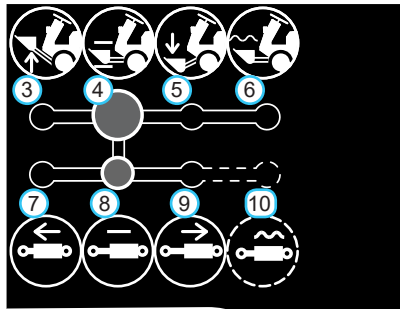

The SDLA (Speed, Direction, Lift, and Auxiliary) is the primary control for the power unit and consists of two levers. The primary SDLA control lever (L) controls the speed, direction of travel, and lift of the hitch arms. The secondary SDLA control lever (M) controls the auxiliary hydraulic circuit.

S - Speed: the amount of forward or backward movement of the primary SDLA lever controls the ground speed of the power unit.

D - Direction: the forward or backward movement of the primary SDLA lever controls the direction of the power unit.

L - Lift: the lift function of the primary SDLA lever has four positions: Up, Hold, Down, and Float Lock. "Hold" is the default position; this holds the lift arms from moving up or down. Pulling the lever to the left raises the hitch arms. Pushing the lever to the right lowers the hitch arms. Float position is attained by pushing the lever to the right until the float detent locks the lever in place.

A - Auxiliary: the left or right movement of the secondary SDLA lever controls the functions of attachments that require the auxiliary hydraulic circuit. An optional float kit (part # 23.0111-7) is available for the auxiliary circuit.



Foot Pedal (N)

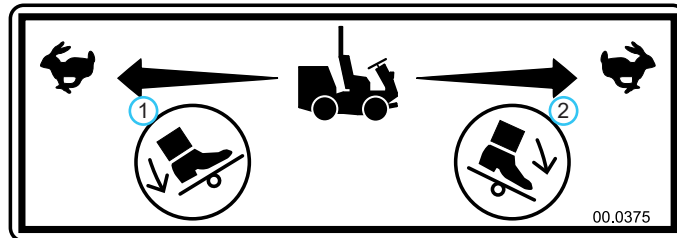

1. Reverse Direction
2. Forward Direction

The foot pedal works in conjunction with the SDLA control lever and can be used to control the speed and direction of the power unit when the operator's hand is removed from the SDLA lever.

Press down on the front portion of the foot pedal to move the power unit in the forward direction. Press down on the rear portion of the foot pedal to move the power unit in the reverse direction. Changing the amount the foot pedal is depressed will immediately change the ground speed of the power unit.

To slow or stop (brake) the power unit, press down on the opposite portion of the foot pedal (i.e. if you are traveling forward, press down on the rear portion of the foot pedal).

Selector Lever/Parking Brake (O)

When parking the power unit, always move the selector lever to the parking brake position (1) to prevent accidental movement of the machine.

To engage the parking brake, pull the selector lever back toward the operator.

If the operator leaves the seat without first setting the parking brake, the power unit will shut off the engine. The foot pedal and the SDLA control lever are locked from forward or reverse movement when the selector lever is in the parking brake position.

Placing the selector lever in the neutral assist (auto) position (2) engages the neutral assist spring to help return the SDLA control levers to the neutral position. This makes the neutral position easy to select and maintain. The neutral assist (auto) position is recommended when learning the operation of the power unit, loading or unloading, attaching and removing attachments, and whenever the operator is unsure of the power unit's response to the task being performed.

Placing the selector lever in the neutral assist off position (3) disengages the neutral assist spring. This position is designed for experienced operators when

1. Park Brake
2. Neutral Assist (auto)
3. Neutral Assist Off

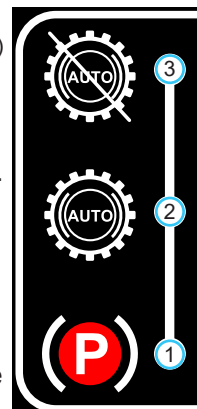

OPERATIONAL CONTROLS

using the power unit in open areas where travel speed and direction are relatively constant and control is easily maintained. The neutral assist off position reduces operator arm fatigue when using the power unit for prolonged periods of time.

CAUTION

Stopping the power unit with the neutral assist lever in the off position requires the operator to manually return the SDLA control lever or foot pedal to the neutral position.

Auxiliary Hydraulic Quick Couplers (P)

The two couplers are a part of the auxiliary hydraulic circuit and are used with an attachment which requires hydraulics (e.g. to angle a dozer blade or rotate the discharge on the snow blower).

Power Take Off (PTO) Switch (R)

Pulling up on the PTO switch engages the electric clutch to provide power to the front attachment.

Pushing down on the PTO switch disengages the electric clutch and applies the clutch brake to stop the attachment. NOTE: the PTO will turn off automatically if the operator leaves the seat. The PTO can be restarted by turning the PTO switch off and then on again.



- 0. PTO Off
- 1. PTO On

Headlight Switch (S)

Pressing the front (1) of the headlight switch turns the headlights and taillights on. Pressing the back (0) of the switch turns the lights off.

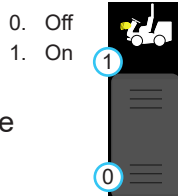

- 0. Off
- 1. On

Throttle Lever (T)



- 1. Slow
- 2. Fast

Moving the throttle lever forward toward the fast position (2) increases the engine Revolutions Per Minute (RPM). Moving the throttle lever backward toward the slow position (1) decreases the engine RPM.

Seat Latch Strap (U)

The seat latch strap secures the seat during transport of the power unit.

To secure the seat, place the tab on the end of the seat latch strap over the seat latch pin. Install the linch pin through the hole in seat latch pin to secure.

To release the seat so that it can be tilted forward for service, remove the linch pin and lift the tab on the seat latch strap off the seat latch pin.

Transmission Neutral Levers (V)

CAUTION

Never shift the transaxles to neutral while under load, while moving, or while on a slope.

Always place the selector lever in the parking brake position while shifting into neutral.

Always re-engage both transaxle levers when pushing or towing of power unit is complete.

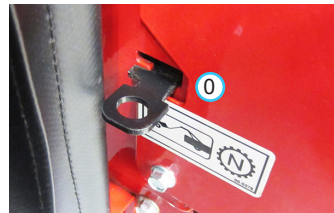

0. Neutral



1. Transaxle Engaged

In the event the power unit must be pushed or towed, both the front and rear transaxles must be shifted into neutral position. Lift up on each lever, pull the lever out toward you until the tab clears the frame, and lower the lever back into the frame notch to secure in the neutral position. NOTE: insert a screwdriver or other tool through the hole in the lever to aid in pulling the lever out to the neutral position.

Horn Switch (AA)

Press the horn switch to sound the signal horn. The horn will sound until the horn switch is released.



- 1. Horn Signal

Directional Signal Switch (BB)

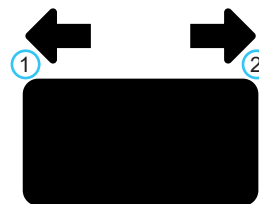

- 1. Left Turn Signal
- 2. Right Turn Signal

Pressing the left portion of the directional signal switch turns the left turn signal on. Pressing the right portion of the directional signal switch turns the right turn signal on. Return the switch to the middle position to turn the signals off. The left and right turn signals will override the hazard flashers.

OPERATIONAL CONTROLS

Hazard Flasher Switch (CC)



- 0. Hazard Flasher Off
- 1. Hazard Flasher On

Pressing the right portion of the hazard flasher switch flashes both directional turn signal lights. Pressing the left portion of the switch turns the hazard flasher lights off. Use of the directional turn signals will override the hazard flashers until the turn signals are turned off.

Work Light Switch (DD)

Depressing the front (1) of the work light switch turns the work lights on. Pressing the back (0) of the switch turns the work lights off.

- 0. Off
- 1. On



Strobe Light Switch (EE)

Pressing the front (1) of the strobe light switch turns the strobe light on. Pressing the back (0) of the switch turns the strobe light off.

- 0. Off
- 1. On



12 Volt Rear Switches & 4-Pin Socket (FF, GG, & HH)

The rear 4-pin socket provides electrical power to rear mounted attachments that are equipped with electrical controls. (e.g. ES220 Spreader)

The switches turn on and off the electrical power to the rear 4-pin socket.

Pressing the left portion (1) of the on/off switch turns electrical power to the 4-pin socket on. Pressing the right portion (0) of the switch turns electrical power off.

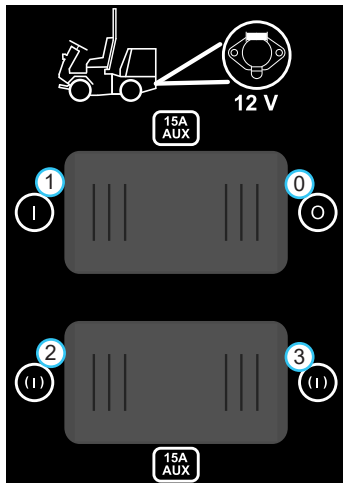

- 0. Off
- 1. On
- 2. Momentary On
- 3. Momentary On

Pressing the left (2) or right (3) portion of the momentary on/off/momentary on switch turns electrical power to the 4-pin socket on. Releasing the switch turns electrical power off.

12 Volt Front Switches & 4-Pin Socket (RR, SS, & TT)

The front 4-pin socket provides electrical power to attachments that are equipped with electrical controls. (e.g. broom rotation actuator)

The switches turn on and off the electrical power to the front 4-pin socket.

Pressing the top portion (1) of the on/off switch turns electrical power to the 4-pin socket on. Pressing the bottom portion (2) of the switch turns electrical power off.

Pressing either the top (3) or bottom (4) momentary on switch turns electrical power to the 4-pin socket on. Releasing the switch turns electrical power off.

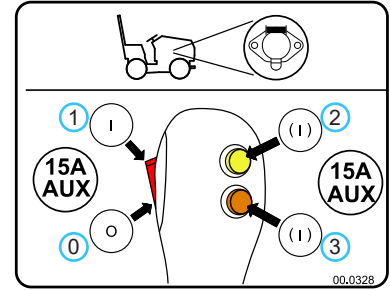

- 0. Off
- 1. On
- 2. Momentary On
- 3. Momentary On

Front Hitch Valve (MM)

The front hitch valve is used to control the lowering of the front hitch.

Turning the knob on the front hitch valve counterclockwise

increases the speed at which the front hitch and attachment can be lowered.

Turning the knob clockwise decreases the speed at which the front hitch and attachment can be lowered.

The front hitch and attachment can be locked in any position so that it will not lower, by turning the front hitch valve knob clockwise until it is completely closed.

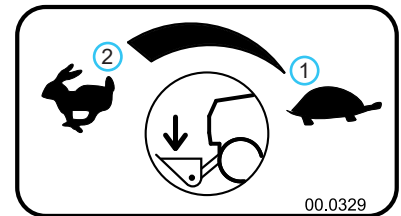

- 1. Slow/Locked
- 2. Fast

GENERAL OPERATION

Daily Inspection

WARNING

Always set the parking brake, shut off power unit engine, remove the ignition key, and ensure all moving parts have come to a complete stop before inspecting components, or attempting any repair or adjustment.

1. Park power unit on a level surface, with the engine shut off and all fluids cold.
2. Perform a visual inspection of the power unit. Look for loose or missing hardware, damaged components, or signs of wear.
3. Inspect the ROPS structure and seat belt for damage or signs of wear.
4. Inspect the battery, electrical connections, and lights.
5. Ensure parking brake tension is properly adjusted.
6. Inspect hydraulic hoses, hydraulic fittings, and fuel lines to ensure tight, leak free connections.
7. Inspect belts for damage or excessive wear. Service as required.
8. Check the power unit's engine oil level, hydraulic oil level, coolant level, and fuel level. Add fluid or service as required.
9. Ensure the radiator screen and engine compartment are clean. Inspect the air filter restriction gauge.
10. Check tires for proper inflation.
11. Test the operator safety interlock system.

Starting The Engine

CAUTION

Do not use ether or starting fluids. Use of starting fluids in the air intake system may be potentially explosive or cause a runaway engine condition. Use of starting fluids could result in engine damage and/or personal injury.

CAUTION

Allow time for hydraulic oil to circulate before operating the power unit. Severe damage could result to the hydraulic system if adequate warm up isn't allowed. Warm up time is increased in colder weather.

The 3400 is equipped with an interlock system for operator safety. The safety interlock system requires the parking brake to be engaged.

1. Turn the fuel shut-off valve to the On position.
2. Turn the battery disconnect switch to the On position.
3. Move the throttle lever to just past the half throttle position.
4. Turn the ignition key to the run position to activate the glow plugs for preheating the combustion chamber. When the glow plug indicator light turns off, the engine is ready to start. If the engine is at operating temperature, the engine does not need to be preheated. If the ambient temperature is below 23° F (-5° C), the preheating cycle may need to be repeated prior to starting.

CAUTION

Do not run the electric starter continuously for more than 10 seconds. If the engine does not start right away, wait 30 seconds and try again.

5. Turn the ignition key to the start position and hold to engage the starter. Release the key when the engine starts. NOTE: if engine fails to start, refer to the troubleshooting section.
6. The engine and hydraulic oil must be warmed to operating temperature before operations. Allow the unit to run at approximately 1800 rpm until the hydraulic filter is warm to touch. The hydraulic filter is located at the right rear of the front frame, below the front transaxle neutral link.

GENERAL OPERATION

Forward And Reverse

Verify that the intended path is safe and free from obstacles. Set the selector lever to the desired position (Neutral Assist Auto or Neutral Assist Off).

⚠ WARNING

Never remove your right hand from the SDLA control lever unless you are using the foot pedal to control speed and direction. All direction, speed, and braking are controlled by the SDLA lever or the foot pedal. Depending on the terrain or rate of speed, more force may be required to maintain speed, change direction, or brake. Your hand or foot must always be ready to brake or stop the power unit.

Power unit movement is controlled by moving the SDLA control lever in the desired direction of travel. Push the SDLA control lever forward to move power unit in the forward direction. Pull the SDLA control lever backward to make the power unit move in the reverse direction. Changing the amount the SDLA control lever is moved, instantly changes the ground speed of the power unit. Moving it one half of the stroke will result in approximately one half of the maximum ground speed. Moving it to the end of the stroke will result in maximum ground speed.

The foot pedal can be used to control speed and direction instead of the SDLA control lever.

The SDLA control should be used for precision control in tight spaces or when connecting an attachment. The foot pedal is better suited to controlling speed and direction in open areas.

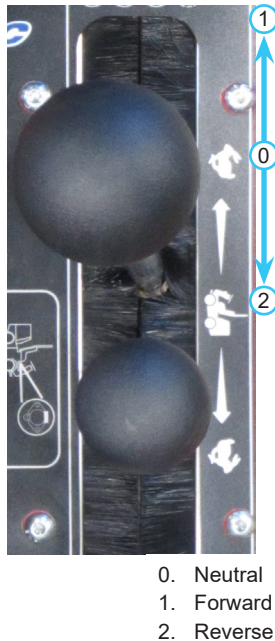

Stopping The Power Unit

To slow or stop the power unit, move the SDLA control lever or foot pedal in the opposite direction that you are traveling. Return the SDLA control lever or foot pedal to the neutral position to make a complete stop. If in the case of an emergency, the power unit cannot be stopped with the SDLA control lever, pull back the selector lever to engage the parking brake.

⚠ CAUTION

If the parking brake is engaged while the power unit is moving, the engine will shut off and the power unit will come to an abrupt stop.

Shutting Off The Engine

1. Park the power unit on a level surface and set the parking brake.
2. Move the throttle lever to the slow idle position.
3. Allow the engine to idle for 3-5 minutes.
4. Turn the ignition key to the off position and remove the key from the ignition switch.
5. When parking the power unit at the end of the day, turn the battery disconnect switch and the fuel shut-off valve to the Off positions.

Attaching

1. Drive the power unit slowly forward into the hitch arms of the attachment. Align the lift arms of the power unit with the attachment hitch arms by raising or lowering the front hitch and complete the engagement.
2. Once completely engaged, move the front hitch latch lever to the locked position.
3. Engage the parking brake and shut off the engine.
4. Place the attachment belt onto the PTO drive pulley on the power unit. Ensure the belt is properly seated in each pulley.*
5. Engage the attachment's PTO belt tensioner.*
6. Wipe the attachment's hose ends clean, and connect to the power unit's hydraulic quick couplers.* If equipped, connect the hoses and quick couplers so the red indicators are paired together and the yellow indicators are paired together.
7. Connect the electric plug to the matching socket.*

Refer to attachment manual for additional details.

*Applies only if the attachment is equipped.

GENERAL OPERATION

Detaching

1. Park the power unit on a level surface and set the parking brake.
2. Fully raise the front hitch and attachment and set the weight transfer to 0.
3. Lower the attachment to the ground and place the primary SDLA lever in the float position.
4. Shut off power unit engine.
5. Disengage the attachment's PTO belt tensioner.*
6. Remove the attachment belt from the PTO drive pulley of the power unit.*
7. Move the secondary SDLA lever left and right to release pressure from the auxiliary hydraulic circuit and disconnect the hydraulic quick couplers from the power unit.*
8. Disconnect the electric plug from the socket on the power unit.*
9. Move the front hitch latch lever to the unlocked position.
10. Restart the power unit and slowly back away from the attachment.

Refer to attachment manual for additional details.

*Applies only if the attachment is equipped.

Operating Attachments

Refer to the operator's manual for each attachment for the proper operation and use of the particular attachment that is being operated.

Front Hitch

The front hitch is used to secure attachments to power unit, and to raise and lower the attachment. The front hitch is controlled by the primary SDLA lever. Pull the lever to the left to raise the attachment, push the SDLA lever to the right to lower the attachment. The primary SDLA is equipped with a 'float' position. Push the SDLA lever to the far right position until the float detent engages and stays in place to operate in float.

PTO Drive Belt & Pulley

If the attachment requires a drive belt, release the attachment's PTO belt tensioner and install the attachment belt around the drive pulley at the location shown above. When the belt is in place around the drive pulley, engage the attachment's PTO belt tensioner.

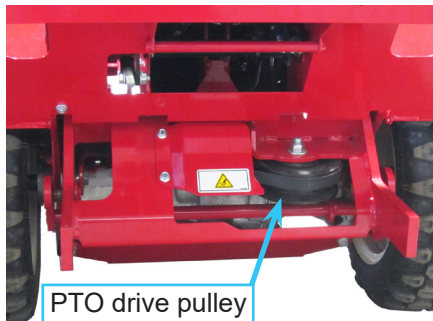

Front Auxiliary Couplers

CAUTION

EQUIPMENT DAMAGE!

Dirt and other debris in hydraulic system can cause damage to the system. Wipe clean the mating parts of the couplers before coupling. Use protective rubber plugs over hydraulic couplers when not in use.

If attachment requires auxiliary hydraulics, couple the attachment hoses with the front auxiliary couplers. This is done by sliding the collar of the coupler rearward and inserting the end of the attachment hose into the coupler and releasing the collar. If the collar will not snap forward on its own, pull it forward manually.

The couplers that the hoses are attached to will affect which way the secondary SDLA lever is pushed to control the action of the attachment. If the attachment is equipped with red and yellow indicators, connect the hoses and quick couplers so the red indicators are paired together and the yellow indicators are paired together. If the hoses are connected and the action is not the desired motion, then switch the hoses the couplers are attached to.

Auxiliary couplers are controlled by moving the secondary SDLA lever left or right.

NOTE: Pressure build-up in the attachment hose and the power unit couplers may occur, causing difficult installation of hoses. If hoses do not easily connect, try one or both of the following steps:

1. To release the pressure from power unit couplers, turn off engine and move the secondary lever of the SDLA right and left to release pressure in the power unit's hydraulic circuit.
2. To release pressure in the attachment hose, loosen one of the hose ends and retighten when pressure is released.

WARNING



Hydraulic fluid is under high pressure and can penetrate skin, causing injury. Keep hands, face, and body away from pinholes or nozzles that eject hydraulic fluid under high pressure.

GENERAL OPERATION

Weight Transfer

The weight transfer system transfers weight from the attachment to the front wheels of the power unit when the front hitch is in float or assists in lifting the attachment. Transferring weight from the attachment to the power unit increases the traction control, improves hillside maneuverability, aids in lifting the attachment, reduces steering effort, and lessens the attachment resistance when in contact with the ground.

The operator can select different transfer rates by selecting one of the four positions from no weight transfer (0) to maximum weight transfer (3). Set the weight transfer to 0 when attaching or detaching any attachment.

To set the weight transfer, raise the front hitch to its maximum height and move the weight transfer select lever to the desired position.

Selecting the proper amount of weight to transfer depends on attachments, ground conditions, and operator preference. A lightweight attachment (e.g. LA162 power blower) will not go down with full weight transfer on. With full weight transfer on, and mowing in the float position, the mower may not come down quickly enough when going through uneven terrain. Power unit speed or weight transfer rate must be reduced.

Roll-Over Protection System (ROPS)

WARNING

Keep the ROPS locked in the upright position and the seat belt securely fastened during operation. Failure to do so could result in serious injury or loss of life.

The 3400 is equipped with a fold down ROPS that allows the power unit to access areas of low overhead clearance. Lower the roll bar only when absolutely necessary and raise the roll bar to the upright position as soon as clearance allows.

WARNING

Do not wear a seat belt when the roll bar has been lowered to the down position.

To lower the roll bar:

1. Remove the pins from the front holes (1) of the right and left hinge plates.

2. Fold the roll bar down and install the pins in the rear holes (2) of the hinge plates to lock in place.



1. Locked Upright

2. Locked Folded Down

To raise the roll bar:

1. Remove the pins from the rear holes (2) of the right and left hinge plates.
2. Raise the roll bar to the upright position and install the pins in the front holes (1) of the hinge plates to lock in place.

12 Volt 4-Pin Auxiliary Outlets (Optional Accessory)

Certain attachments require a 12 volt auxiliary outlet. Plug the attachment's 12 volt power cord into the 12 volt 4-pin outlet. The actions of the front 12 volt outlet are controlled by an on/off switch and two momentary on buttons on the SDLA handle. The actions of the rear 12 volt outlet are controlled by an on/off switch and a momentary on/off/on switch on the side dash panel beside the SDLA control. The momentary buttons or switch are used for controlling movement that is only used for a brief time. The on/off switches are used to activate equipment or select different functions.

GENERAL OPERATION

Operating On Slopes

WARNING

AVOID PERSONAL INJURY!

- Operation on slopes decreases power unit stability and increases the potential for unexpected difficulties. Only experienced operators should operate the power unit on slopes and extra caution should be exercised.
- Do not exceed the maximum degree of operation of 20°.
- Avoid uneven, loose, or wet terrain.
- Stay clear of drop-offs, holes, ditches, rocks, or objects that could cause a sudden and/or unexpected force on the power unit.
- Make slow and cautious starts, stops, and turns.
- Turn downhill when possible and/or reduce the degree of turns.
- Assure a sufficient supply of fuel for continuous operation. A minimum of one-half tank of fuel is recommended.
- To prevent fuel spillage, do not remove the fuel tank cap while power unit is on a slope.
- Failure to follow items listed or to use common sense while operating on slopes can result in injury or death. Always operate on slopes with caution.

Maintain sufficient fuel in tank to ensure continuous operation.

Cease operation if power unit stability is questionable, or if the operator is uncomfortable or unsure of continuing safely. Do not operate on slopes greater than 20°.

Attachments can affect the stability of the power unit. Each attachment will affect the power unit differently.



Attention

Some attachments or accessories have further limitations on maximum angle of operation. Refer to individual attachment operator's manuals for limitations.

Increase the amount of weight being transferred to the power unit from the attachment while operating on slopes. Refer to Weight Transfer section.

Always operate carefully and in a manner that does not compromise safety.

Always keep the roll bar in the upright, locked position and fasten yourself securely with the seat belt!

Operation in Water, Mud, Snow, or Ice

WARNING

Operation in water, mud, snow, or ice decreases power unit traction and increases the potential for unexpected difficulties or loss of control. Reduce speed and exercise caution.

WARNING

Operation on frozen bodies of water can be dangerous. The machine could fall through the ice and cause the operator to drown. Never operate on ice unless you have verified the thickness of the ice and that the travel path is safe.

CAUTION

Operation in water may cause damage to the hydraulic system, axles, or other parts. If the water level reaches the tire rim, the water is too deep.

Towing Or Pushing The Power Unit



Attention

Avoid damage to your power unit! Before towing, read and understand the information below. Severe damage will occur to unit if proper towing procedure is not followed.

CAUTION

Failure to place the transaxles in neutral when towing or pushing the power unit may result in damage to the power unit drivetrain.

If the power unit needs to be moved without the engine running, it is important to remember to place the transaxles in neutral by pulling both front and rear transaxle neutral levers out to the neutral position. With the transaxles in neutral and the parking brake disengaged, the power unit can freewheel. This function is designed for slow, level, short distance towing only. Use extreme caution when towing or pushing the power unit; steering may not function.

Always re-engage both transaxle neutral levers when towing is complete to prevent a freewheeling hazard if the parking brake is released.

SERVICE

⚠ WARNING

Always set the parking brake, shut off power unit engine, remove the ignition key, and ensure all moving parts have come to a complete stop before inspecting components or attempting any repair or adjustment.



Attention

Ventrac recommends that service be performed by a qualified technician. If you are unsure how to perform the service procedure(s), contact your Ventrac dealer.



Attention

If any component requires replacement, use only original Ventrac replacement parts.

Service And General Maintenance

Proper and timely service of this power unit is critical to keep the power unit in a safe and reliable operating condition. Follow the maintenance schedule at the end of the service section. For convenience, a frequent service guide decal and a quick reference chart decal have been placed on the power unit inside the left hood panel.



Cleaning And Appearance Care

For best results, and to maintain the finish of the power unit, clean or wash the power unit to remove accumulated clippings, leaves, dirt, gravel, and salt deposits when the job is finished.



Attention

To maintain the finish of the power unit, thoroughly wash the equipment after each use to remove any corrosive agents (e.g. salt). Failure to clean the equipment may result in corrosion of (including but not limited to) steel, aluminum, and electrical components. Equipment that will experience repeated exposure to corrosive agents should be pretreated with a corrosion preventative.

⚠ CAUTION

If the engine has been running, it must be allowed to cool in order to prevent damage to the block and exhaust manifold.

Do not direct high pressure water at the engine, air cleaner, muffler, radiator, hydraulic oil cooler, or any electrical components.

Allow the power unit and all components to cool before washing. Refer to the specific service sections for proper cleaning techniques for the engine and radiator. Use mild soap and water to clean the power unit. Harsh chemical cleaners could cause damage to the finish or components.

After cleaning, use touch up paint to repair scrapes.

SERVICE

Service Access Points

Throughout the service section, different access points are referred to. The following list and images identify shields and covers that may need to be removed or opened during service.



- 1. Left Hood Panel
- 2. Seat
- 3. Tunnel Access Cover
- 4. Engine Drive Belt Cover
- 5. Front Frame Canvas
- 6. Left Center Pivot Canvas
- 7. Weight Transfer Access Cover



- 8. Top Hood Panel
- 9. Right Hood Panel
- 10. SDLA Access Cover
- 11. Right Center Pivot Cover



- 12. Rear Panel

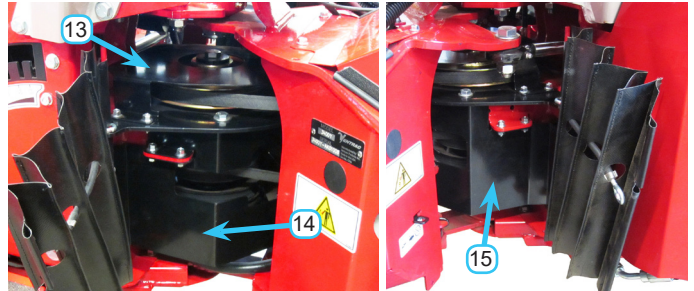

- 13. Top Center Pivot Guard
- 14. Left Center Pivot Guard
- 15. Right Center Pivot Guard

Lubrication Locations

Lubrication is required at the following locations. Refer to the maintenance schedule for service intervals and amount of grease. Refer to Specifications section for grease type.

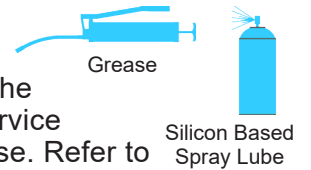

Front of Lift & Steering Cylinders

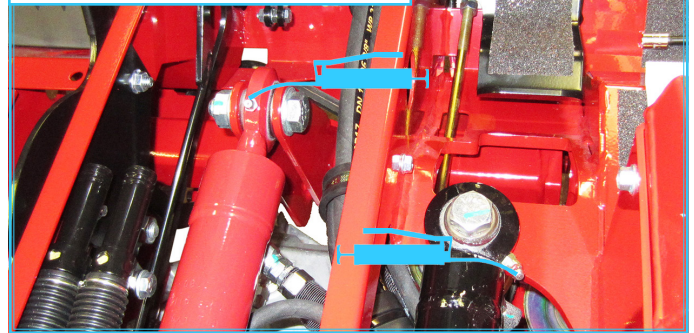

Rear of Steering Cylinder

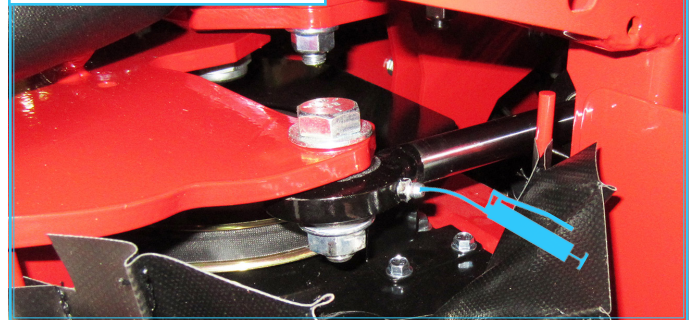

SERVICE

Lubrication Locations (Cont.)

SDLA Pivot & Rear of Lift Cylinder

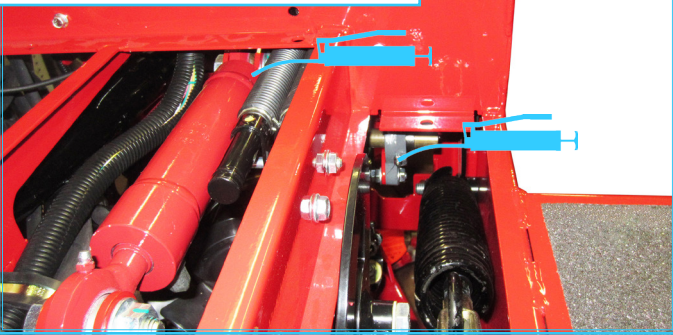

The rear grease fitting on the lift cylinder must be greased from below the cylinder by removing the weight transfer access cover and using a grease gun with a flexible hose.

Connector Link

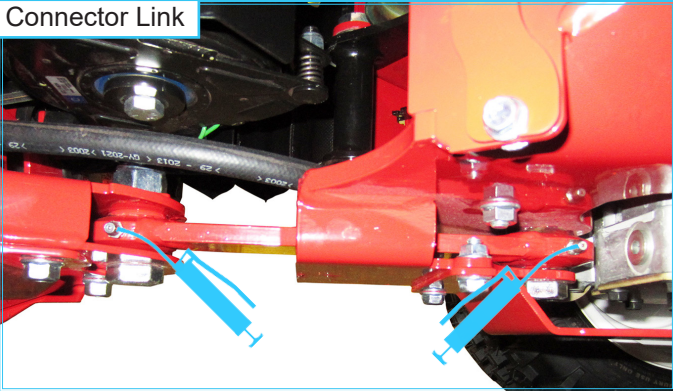

Center Pivot

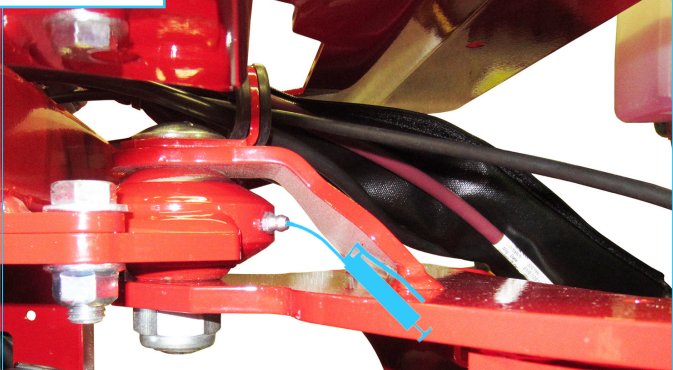

Seat Slides

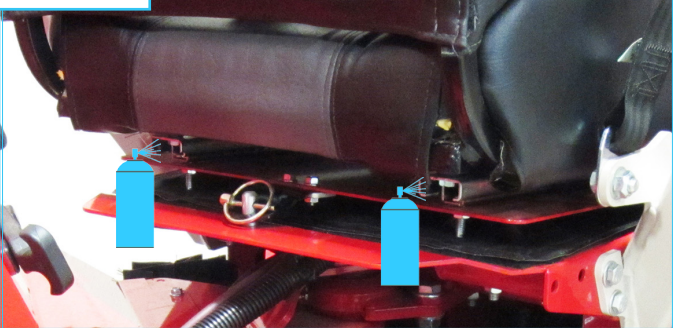

Checking Hydraulic Oil Level

Check the hydraulic oil level when the hydraulic system is cold, prior to operating the power unit. If the hydraulic system is warm, allow one hour for the hydraulic system to cool before checking the oil level. Checking the oil level when the hydraulic system is warm will produce an inaccurate oil level reading.



Attention

After connecting a new attachment or kit that runs off the power unit's hydraulic system, run the attachment through a complete cycle, then stop and check the hydraulic oil level.

1. Park the power unit on a level surface and adjust the steering to aim the power unit straight ahead.
2. Fully raise the front hitch.
3. Engage the parking brake and shut off the engine.
4. Remove the key from the ignition switch and allow time for the hydraulic system to cool.
5. The hydraulic oil tank (A) is located under the top hood panel at the front right corner of the rear frame.

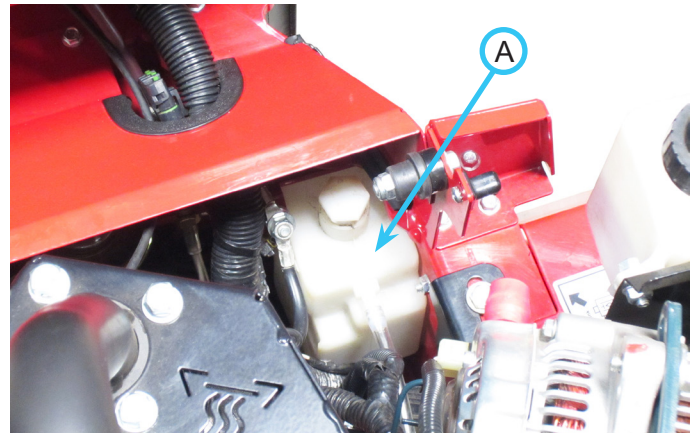

6. Check the oil level in the hydraulic oil tank. The oil level should be centered between the low and full marks on the hydraulic oil tank. NOTE: use a flashlight to inspect level if necessary.
7. If the hydraulic oil level is low, add HydroTorq XL synthetic hydraulic oil until the proper level is reached.

SERVICE

Changing Hydraulic Oil Filter

1. Park the power unit on a level surface.
2. Engage the parking brake and shut off the engine.
3. Remove the key from the ignition switch and allow time for the hydraulic system to cool.

⚠ WARNING

Hot oil can cause severe burns. Allow the hydraulic oil temperature to drop from hot to warm before changing the oil filter.

4. Clean the hydraulic filter (A), the filter head, and the area around the hydraulic filter.

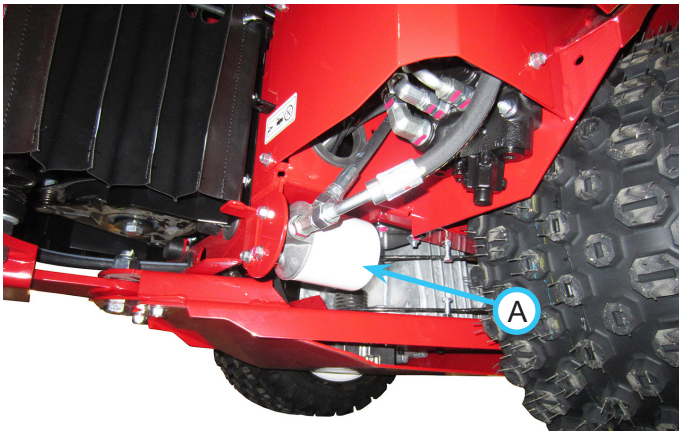

5. Place a small drain pan under the hydraulic filter.
6. Use a filter wrench to unscrew the hydraulic filter from the filter head and allow the oil to drain into the pan.
7. Ensure the filter mounting surface is clean.
8. Apply a thin film of clean oil to the gasket of the new filter and screw the filter onto the filter head until the gasket makes contact with the mounting surface. Tighten the filter an additional 1 turn (may require using a filter wrench).
9. Clean up any spilled oil and dispose of oil and filter in accordance with local laws.

⚠ CAUTION

Oil is hazardous to the environment. Drain oil into an approved container and dispose of used oil in accordance with local laws.

10. If hydraulic oil is being changed at the same time as the filters, skip the remaining steps and proceed to Changing Hydraulic Oil section.
11. Start the power unit and let it run at low idle engine speed for several minutes. Turn the steering wheel to the left and right a couple of times to purge any trapped air out of the hydraulic system.

12. Shut off the power unit engine and allow the power unit to sit for a minimum of five minutes.
13. Check the hydraulic oil level and add HydroTorq XL synthetic hydraulic oil, if necessary. Refer to the manual section for checking hydraulic oil level.
14. Inspect the hydraulic filter for signs of leakage. If any leaks are evident, the filter may need tightened further, or the filter may need to be removed, the gasket and filter mount cleaned, and the filter reinstalled following the procedures for changing the filter.

Changing Hydraulic Oil

1. Wash the underside and sides of both the front and rear transaxles thoroughly.
2. Park the power unit on a level surface and adjust the steering to aim the power unit straight ahead.
3. Fully raise the front hitch.
4. Engage the parking brake and shut off the engine.
5. Remove the key from the ignition switch and allow time for the hydraulic system to cool.

⚠ WARNING

Hot oil can cause severe burns. Allow the hydraulic oil temperature to drop from hot to warm before draining the hydraulic oil.

6. Remove the front transaxle skid plate from the power unit.
7. Place a drain pan (minimum 7 quart / 6.5 liter) under the front transaxle drain.
8. Remove the drain plug (A) from the front transaxle and allow the hydraulic oil to drain from the system. Loosen the cap on the hydraulic oil tank to allow venting.

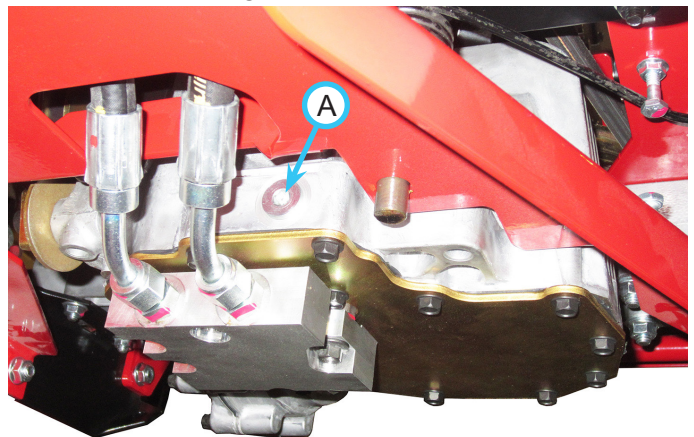

9. Clean the drain plug, reinstall into the front transaxle, and torque to 22 ft-lbs (30 Nm).

SERVICE

10. If hydraulic filter is being changed with the oil, proceed to Changing Hydraulic Oil Filter section before completing the remaining steps in this section.
11. Clean up any spilled oil and dispose of oil and filter in accordance with local laws.

CAUTION

Oil is hazardous to the environment. Drain oil into an approved container and dispose of used oil in accordance with local laws.

12. Reinstall the front transaxle skid plate onto the power unit. Torque bolts to 31 ft-lbs (42 Nm).
13. Add HydroTorq XL synthetic hydraulic oil to the hydraulic oil tank until the oil level is centered between the low and full marks on the oil tank.
14. Start the power unit and let it run at low idle engine speed for several minutes. Turn the steering wheel to the left and right a couple of times to purge any trapped air out of the hydraulic system.
15. Shut off the power unit engine and allow the power unit to sit for a minimum of five minutes.
16. Check the hydraulic oil level and add HydroTorq XL synthetic hydraulic oil, if necessary. Refer to the manual section for checking hydraulic oil level.

Changing Rear Transaxle Differential Oil

1. Remove the rear transaxle skid plate from the power unit.
2. Place a drain pan (minimum 4 quart / 3.8 liter) under the rear axle drain.
3. Remove the drain plug (A) from front of the rear transaxle and allow the hydraulic oil to drain from the transaxle.

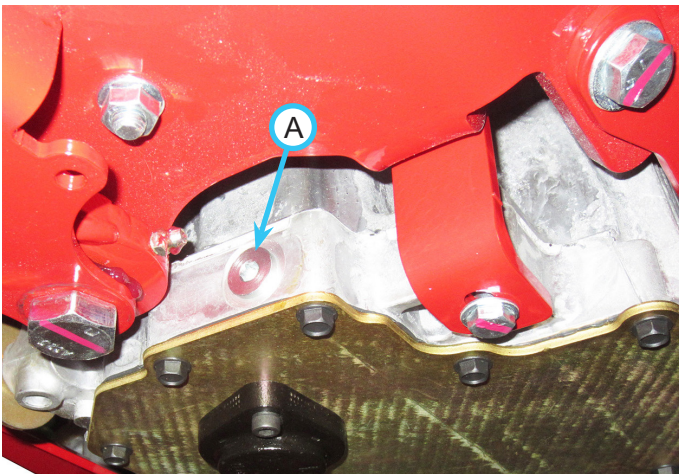

4. Remove the plug (B) on the right side of the transaxle to allow venting.

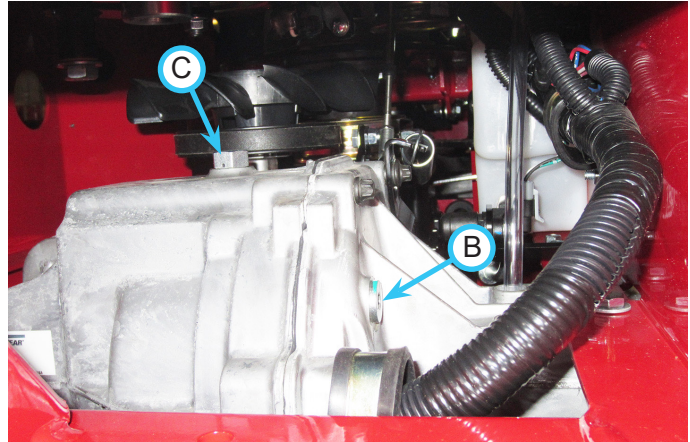

5. Clean the drain plug, reinstall into the rear transaxle, and torque to 22 ft-lbs (30 Nm).
6. The rear transaxle can be filled through either the port (B) on the right side of the transaxle or by removing the vent plug (C) from the top of the transaxle, using either a funnel with a flexible spout or a funnel inserted into a piece of 7/16" outside diameter flexible tubing.
7. Add HydroTorq XL synthetic hydraulic oil (approximately 3 qt / 2.8 L) to the rear transaxle until level with the bottom of the side port (B).
8. Reinstall the side plug and the top vent plug (if removed) into the rear transaxle and torque to 22 ft-lbs (30 Nm).
9. Clean up any spilled oil and dispose of oil and filter in accordance with local laws.

CAUTION

Oil is hazardous to the environment. Drain oil into an approved container and dispose of used oil in accordance with local laws.

10. Reinstall the rear transaxle skid plate onto the power unit. Torque bolts to 210 in-lbs (24 Nm).

Checking Engine RPM

Check engine RPM when engine is warmed up and not under load. Observe tachometer:

- Low idle speed = 1625 \pm 25 RPM
- High idle speed = 2825 \pm 25 RPM

If engine RPM is incorrect, contact your local Ven-trac dealer.

SERVICE

Checking Engine Oil Level



Attention

Avoid Engine Damage!

Failure to check the oil level regularly could lead to serious damage to your engine, if the engine is run with an incorrect oil level.

- Check the engine oil level with the power unit sitting on a level surface and with the engine shut off and the oil cold.
- Keep oil level between the **FULL** and **ADD** marks.
- Do not add oil with the engine running.

1. Park the power unit on a level surface.
2. Engage the parking brake and shut off the engine.
3. Remove the key from the ignition switch and allow the engine and oil to cool.
4. Remove the top hood panel to access the engine compartment.
5. Remove the oil dipstick (A) from the engine and wipe with a clean cloth.

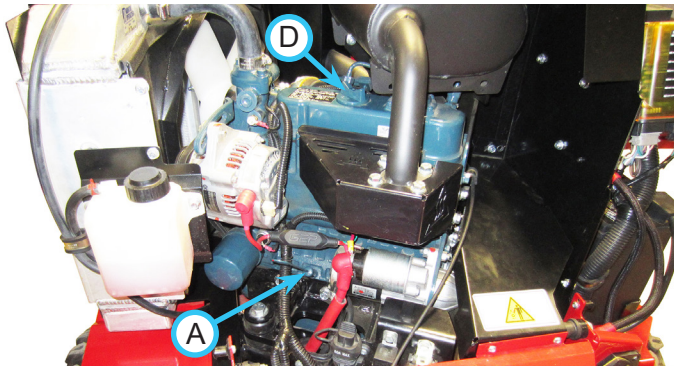

6. Insert the dipstick back into the engine and remove again.
7. Check the oil level. The level should be between the Full (B) and Add (C) marks on the dipstick.

(C)

(B)

8. If the oil level is low, remove the oil fill cap (D) and add small amounts of engine oil to bring the oil level no higher than the Full (B) level on the dipstick.
9. If oil level is above the Full (B) mark, drain some engine oil to achieve the proper level.
10. Reinstall the dipstick and the oil fill cap and replace the top hood panel.

Changing Engine Oil And Filter

CAUTION

Contact with engine oil can irritate your skin. Wear protective gloves when working with engine oil. If you come in contact with engine oil, wash it off immediately.

CAUTION

Oil is hazardous to the environment. Drain engine oil into an approved container. Dispose of used engine oil in accordance with local laws.

1. Start the power unit engine and allow it to run until the engine reaches operating temperature.
2. Park the power unit on a level surface.
3. Engage the parking brake and shut off the engine.
4. Remove the key from the ignition switch.
5. Remove the top hood panel to access the engine compartment.
6. Place a drain pan below the oil drain (A) located underneath the rear frame just inside the left rear wheel.

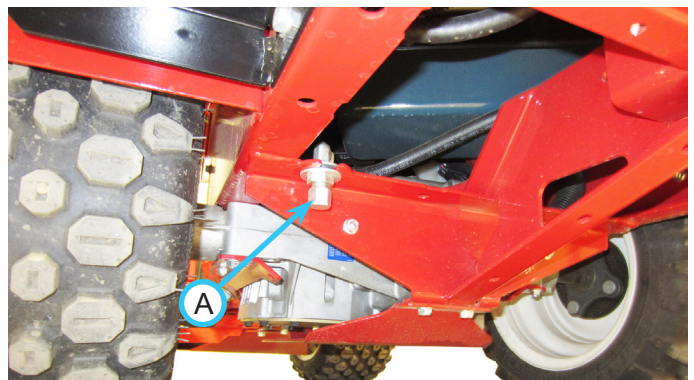

WARNING

Hot engine oil can cause severe burns. Allow the engine temperature to drop from hot to warm before draining the oil.

7. Remove the drain cap from the oil drain and drain into the pan while the oil is warm.

SERVICE

- Remove the oil filter (B) located on the side of the engine. Turn the filter counterclockwise to remove.

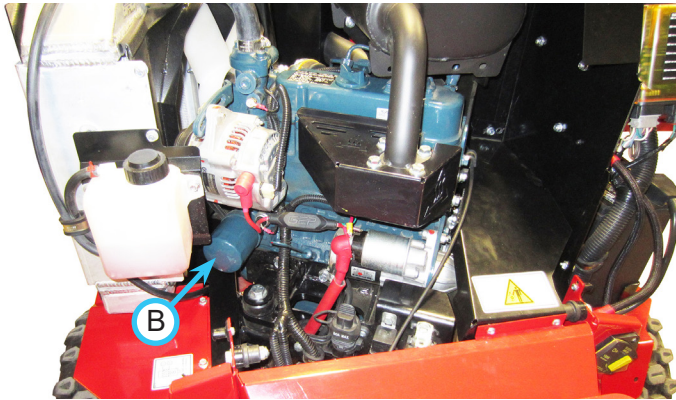

- Wipe the filter mounting surface with a clean cloth.
- Apply a thin film of clean oil to the gasket of the new oil filter.
- Install the new filter turning it clockwise until the gasket makes contact with the mounting surface. Tighten the filter 1/2 to 3/4 turn more by hand.
- Install the drain cap onto the oil drain. DO NOT over-tighten.
- Remove the oil fill cap.
- Add oil to the engine. (Refer to Engine Owner's Manual for proper oil specifications and capacity.)

Attention: Engine Oil Recommendation

For optimal engine life and performance, use Ventrac Full Synthetic Engine Oil.
Part # 15.0037-1



- Install the oil fill cap and wipe up any oils spills.
- Start the engine and run at slow idle for approximately 2 to 3 minutes.
- Shut off the engine and remove the ignition key.
- Check for oil leaks around the oil filter.
- Check the engine oil level after allowing the engine to cool for approximately 2 minutes. Add oil, if necessary.
- Replace the top hood panel.

Inspecting & Resetting The Air Filter Restriction Gauge

The air filter restriction gauge (A) is located on the air filter canister outlet to the engine. It can be viewed by looking between the air intake baffle and the exhaust baffle.

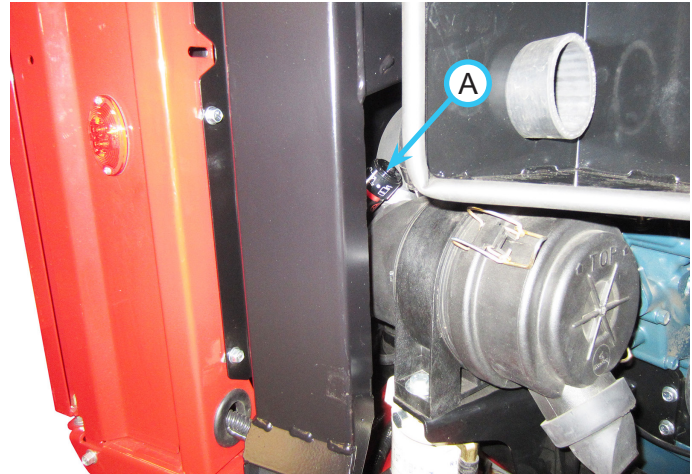

To check the air filter restriction gauge:

- Park the power unit on a level surface.
- Engage the parking brake and shut off the engine.
- Remove the key from the ignition switch.
- Remove the rear panel.
- Check the inspection window (B) on the restriction gauge. When the air flow restriction reaches the set limit, the inspection window will turn red to indicate the air filter must be replaced.
- After replacing the primary air filter, reset the filter restriction gauge by pressing the button (C) on the top of the gauge.
- Replace the rear panel.

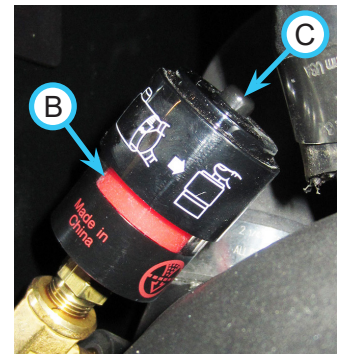

SERVICE

Changing Air Filter Elements

⚠ CAUTION

When the air filter elements are removed, an opening is created to the internal parts of the engine.

Be sure nothing falls into the canister that could make its way into the engine. Have the new filter elements ready to install immediately after removing the old filter elements.



Attention

Avoid damage to your engine!

Improper service to the engine air filter can result in severe engine damage.

- Inspect filter restriction gauge daily in extreme heat, dust, or other severe conditions.
- Never run the engine without a proper air filter installed.
- Never wash or clean the paper filter element.

1. Park the power unit on a level surface.
2. Engage the parking brake and shut off the engine.
3. Remove the key from the ignition switch and allow the engine to cool.
4. Remove the rear panel and locate the engine air cleaner assembly (A).

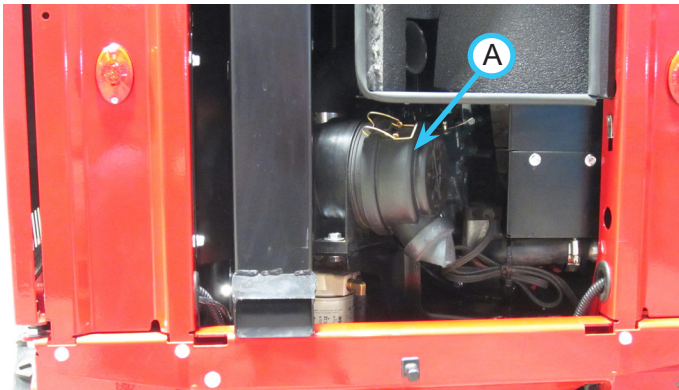

5. Release both latches (B) on the filter assembly and unhook the latches from the filter housing.

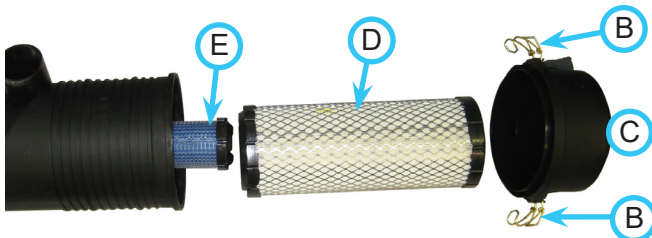

6. Remove the filter cap (C).
7. Remove and discard the primary air filter element (D).

8. If the safety air filter element (E) is scheduled for replacement, remove and discard the safety air filter element.
9. Install the new air filter element(s).
10. Install the filter cap and fasten both latches.
11. Replace the rear panel.

Filling The Fuel Tank

⚠ DANGER

Fuel is flammable and/or explosive. Follow all safety instructions in the Fuel Safety section of this manual and in the engine operator's manual.

⚠ WARNING

Long term exposure to fuel vapors can cause serious injury or illness. Avoid prolonged breathing of fuel vapors.

If fuel is spilled on skin or clothing, change clothing and wash affected skin immediately.

⚠ CAUTION

Avoid damage to your engine!

Only use fuel that meets the specifications required for your engine. Refer to the engine operator's manual for the proper grade and specifications of fuel for your engine.

1. Park the power unit on a level surface.
2. Engage the parking brake and shut off the engine.
3. Remove the key from the ignition switch and allow the engine to cool.
4. Open the left hood panel.
5. Wipe any dust and dirt off the fuel cap to prevent dirt from falling into the fuel tank, and remove the fuel cap.
6. Add fuel to the tank until the fuel level reaches the bottom of the fuel neck*. Do not overfill by filling the fuel neck, as this may cause engine flooding. Keep the fuel nozzle in contact with the rim of the fuel neck until fueling is completed.
7. Replace the fuel cap and tighten.
8. Wipe up any fuel spills and allow fuel vapors to dissipate before starting the engine.
9. Close the left hood panel.

*If power unit will not be used after filling fuel tank, only fill the tank to within 1" (25 mm) of the bottom of the fuel neck to allow room for fuel expansion from temperature changes. Failure to do so may cause engine flooding.

SERVICE

Servicing The Fuel Filter/Water Separator

The fuel filter/water separator is located underneath the air filter. Water and sediment can be observed through the glass bowl on the bottom of the filter.

1. Drain water through the valve (A).
2. Remove sediments through the plug opening (B).

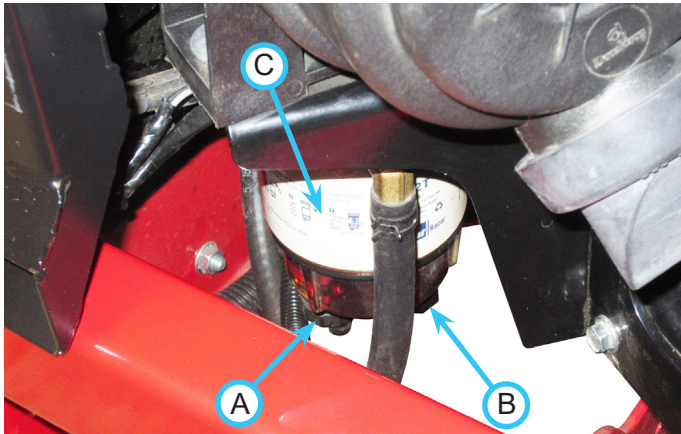

Changing The Fuel Filter

1. Park the power unit on a level surface.
2. Engage the parking brake and shut off the engine.
3. Remove the key from the ignition switch.
4. Turn the fuel shut-off valve to the Off position.
5. Remove the rear panel.
6. Remove the fuel filter canister (C).
7. Replace the fuel filter element.
8. Install the fuel filter canister.
9. Turn the fuel shut-off valve to the On position.
10. Prime the fuel system, if necessary.

Priming The Fuel System

1. Turn the ignition key to the On position for about 30 seconds. The operator should hear the fuel pump operating.
2. Start the power unit. Repeat step 1 if necessary.

Checking The Fan (Alternator) Belt

WARNING

Avoid Personal Injury!

Fingers or loose clothing can get caught in rotating parts. Shut off the power unit engine, remove the ignition key, and wait for all moving parts to stop rotating before working on the power unit.

1. Park the power unit on a level surface.
2. Engage the parking brake and shut off the engine.
3. Remove the key from the ignition switch and allow the engine to cool.
4. Turn the battery disconnect switch to the Off position.
5. Remove the top hood panel to access the engine compartment.
6. Check the fan belt (A) for excessive wear, cracks, or damage. Replace if necessary.
7. Check the fan belt for proper tension. Depress the belt halfway (B) between the drive pulley and the alternator pulley and measure the belt deflection at the specified force 22 lbf (98 N, 10 kgf). The belt deflection should measure 1/4 to 3/8 inches (7 to 9 mm). If the belt deflection is not within specifications, the belt tension must be adjusted.

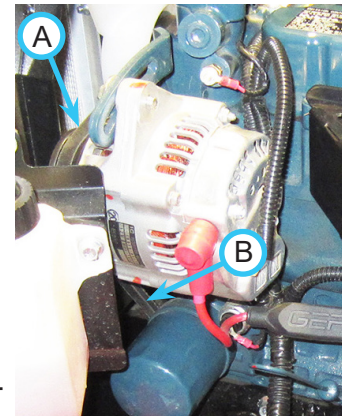

SERVICE

Adjusting Fan (Alternator) Belt Tension

⚠ WARNING

Avoid Personal Injury!

Fingers or loose clothing can get caught in rotating parts. Shut off the power unit engine, remove the ignition key, and wait for all moving parts to stop rotating before working on the power unit.

1. Turn the battery disconnect switch to the Off position.
2. Loosen the alternator adjustment bolt (A).
3. Loosen the bottom alternator mounting bolt (B).
4. Move the alternator in the desired direction.
5. Tighten the alternator adjustment bolt.
6. Tighten the bottom alternator mounting bolt.
7. Recheck the belt for proper tension.

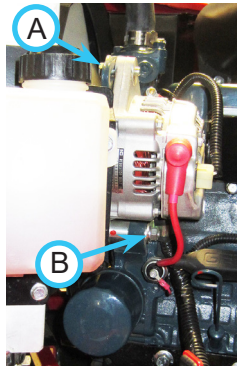

Cleaning Engine Compartment & Engine

Clean the engine compartment and engine daily or prior to each use, to reduce the risk of engine overheating or ignition of accumulated debris.

1. Park the power unit on a level surface.
2. Engage the parking brake and shut off the engine.
3. Remove the key from the ignition switch and allow the engine to cool.
4. Remove the top hood panel and the rear panel to access the engine compartment.
5. Remove accumulated debris and dust from the engine compartment and engine.
6. Refer also to Cleaning The Radiator And Screen section of this manual.

Servicing The Cooling System

⚠ WARNING

Avoid Personal Injury!

If the unit has been running, the radiator and radiator coolant will be hot and can burn skin! Built-up pressure in the radiator can cause an explosive release of coolant if the radiator cap is removed:

- Shut off engine and allow to cool.
- Do not remove the radiator cap unless the radiator and engine are cool enough to touch with bare hands.
- Slowly loosen cap to the first stop to release all the pressure before removing completely.

⚠ WARNING

Avoid Personal Injury!

Wear personal protective equipment to protect eyes and hands when opening radiator cap to protect against the pressure in the radiator.

If coolant is spilled on skin or clothing, change clothing and wash affected skin immediately.

⚠ CAUTION

Coolant is poisonous to humans and animals and is hazardous to the environment. Drain coolant into an approved container. Dispose of used coolant in accordance with local laws.



Attention

Avoid damage to your engine!

Using incorrect coolant mixture and/or type can cause engine damage. Use only a mixture of 50% distilled water and 50% ethylene glycol antifreeze.

Recommended antifreeze: a low silicate, phosphate free antifreeze (ethylene glycol) containing supplemental coolant additives (SCA's) to inhibit corrosion and rust.

Dye Color does not determine the antifreeze properties; ethylene glycol antifreeze of different colors can be mixed.

SERVICE

Checking The Cooling System

1. Park the power unit on a level surface.
2. Engage the parking brake and shut off the engine.
3. Remove the key from the ignition switch and allow the engine to cool.
4. Open the right hood panel and remove the top hood panel to access the engine compartment.
5. Check the coolant level in the coolant recovery tank (A). When cold, the coolant recovery tank should be approximately half full of coolant.
6. If the coolant level is low, add coolant to the tank and reinstall the cap.
7. If the coolant recovery tank is empty, slowly open the radiator cap (B) to the first stop to allow any pressure to release. Press down on the cap slightly and continue to turn counter-clockwise to remove the cap from the radiator.
8. Check to ensure the coolant level is up to the bottom of the filler neck.
9. If the coolant level is low, add coolant to the radiator until it reaches the bottom of the filler neck.
10. Install the radiator cap.
11. Inspect the radiator hoses and clamps for leaks and deterioration. Replace as necessary.
12. Replace the top hood panel and close the right hood panel.

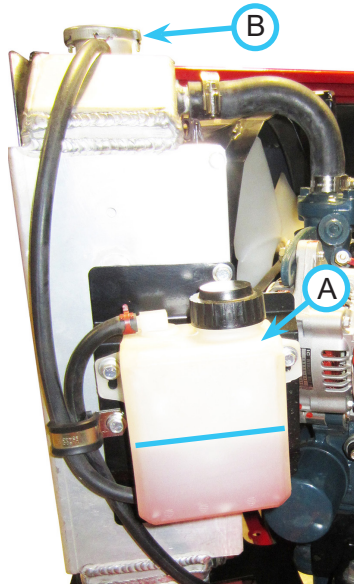

Cleaning The Radiator And Screen

1. Park the power unit on a level surface.
2. Engage the parking brake and shut off the engine.
3. Remove the key from the ignition switch and allow the engine to cool.
4. Open the right hood panel and remove the top hood panel to access the engine compartment.
5. Remove debris from the radiator screen (A) in the right hood panel using a brush, compressed air, or water.
6. Remove the screen panel (B) from the radiator and check the radiator fins for debris buildup.
7. If necessary, clean debris from the radiator using low pressure compressed air or water.
8. Check radiator fins for damage.
9. Install the screen panel.
10. Replace the top hood panel and close the right hood panel.

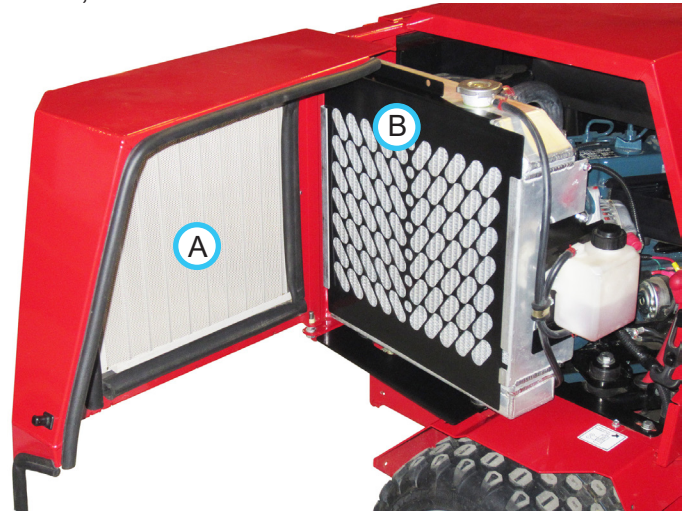

SERVICE

Draining The Cooling System

⚠ CAUTION

Coolant is poisonous to humans and animals and is hazardous to the environment. Drain coolant into an approved container. Dispose of used coolant in accordance with local laws.

1. Park the power unit on a level surface.
2. Engage the parking brake and shut off the engine.
3. Remove the key from the ignition switch and allow the engine to cool.
4. Open the right hood panel to access the radiator.
5. Slowly open the radiator cap to the first stop to allow pressure to release.
6. Place a drain pan or jug under the radiator drain port (A) behind the right rear tire.

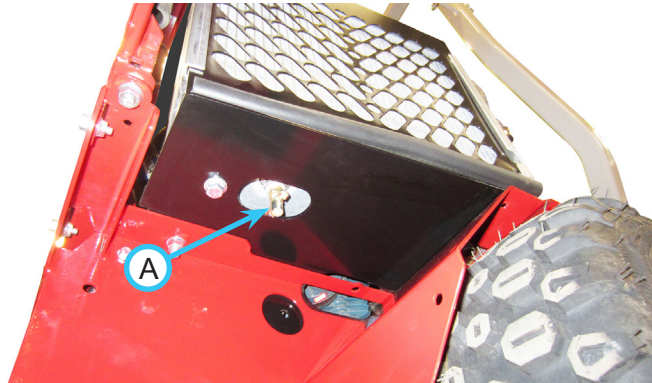

7. Turn the drain valve counterclockwise to open and drain the coolant into the drain pan.

Flushing The Cooling System

1. Drain the cooling system following the procedures in the previous section.
2. Close the radiator drain valve.
3. Add one can of radiator flush to the radiator and fill the radiator with clean water.
4. Install the radiator cap, start the engine, and run until the engine reaches operating temperature (160 - 180 degrees).
5. Shut off the engine and remove the key from the ignition switch.

⚠ WARNING

Hot coolant can cause severe burns. Allow the temperature of the radiator to drop from hot to warm before draining the coolant.

6. Carefully drain the cooling system while the coolant is still warm.
7. Allow the engine and radiator to cool completely.

⚠ CAUTION

Allow engine and radiator to cool completely. Engine damage could occur if cold water is added to a hot engine.

8. Add clean water to the radiator and allow the water to run through the system. Add more water as needed, until the water flowing from the drain valve is clear and free of sediment.
9. After the water has drained completely, close the radiator drain valve.
10. Slowly add the proper coolant (refer to Engine Owner's Manual for the correct type of coolant) to the radiator until the level reaches the bottom of the filler neck. NOTE: residual water may be present in the engine. Adjust the coolant mixture to achieve a 50/50 ratio.
11. Install the radiator cap, start the engine, and run until the engine reaches operating temperature of 160 - 180° F (71 - 82° C).
12. Shut off the engine and allow the engine to cool.
13. Recheck the coolant level when the engine is cold. Add additional coolant if necessary.
14. Replace the top hood panel and close the right hood panel.

SERVICE

Servicing The Battery

⚠ DANGER

The battery produces a flammable and explosive gas. The battery may explode.

- Wear eye protection and gloves.
- Do not smoke near the battery.
- Keep arcs, sparks, and open flames away from batteries.
- Do not allow direct metal contact across the battery posts.
- Remove the negative battery cable first when disconnecting the battery.
- Install the negative battery cable last when connecting the battery.

⚠ WARNING

Avoid Personal Injury!

Battery electrolyte contains sulfuric acid. It is **poisonous** and can cause **severe chemical burns**.

- Wear eye and skin protection.
- Keep skin protected.
- If battery electrolyte is spilled on skin or clothing, change clothing and wash affected skin immediately. Seek medical attention, if necessary.
- If battery electrolyte is splashed in eyes, flush immediately with water for 15-30 minutes and seek immediate medical attention.
- If battery electrolyte is swallowed, get medical attention immediately. Drink large quantities of water, followed by Milk of Magnesia, beaten egg, or vegetable oil. **DO NOT** give fluids that would induce vomiting.

⚠ CAUTION

Batteries contain poisonous and hazardous substances. Dispose of used batteries in accordance with local laws.

Removing The Battery

1. Park the power unit on a level surface.
2. Engage the parking brake and shut off the engine.
3. Remove the key from the ignition switch.
4. Open the left hood panel.

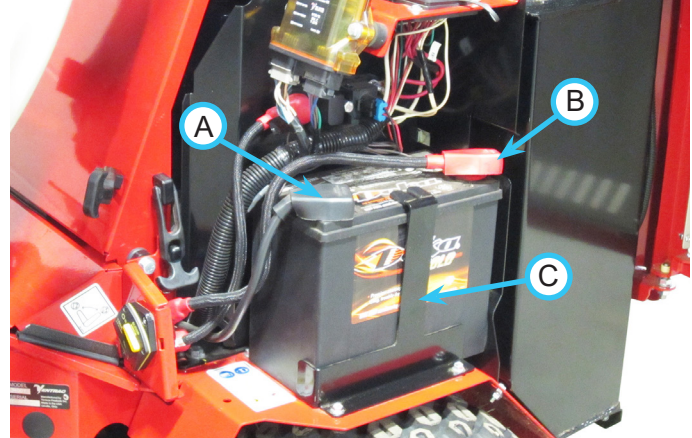

5. Disconnect the negative (-) battery cable (A).
6. Disconnect the positive (+) battery cable (B).
7. Remove the battery retainer (C).
8. Remove the battery.

Installing The Battery

1. Install the battery on the left fender with the negative post to the front.
2. Install the battery retainer and torque the bolt to 210 in-lbs (24 Nm).
3. Connect the positive battery cable to the positive battery post first.
4. Connect the negative battery cable to the negative battery post last.
5. Apply dielectric grease to the battery terminals to prevent corrosion.
6. Place the covers back over the battery terminals.
7. Close the left hood panel.

SERVICE

Cleaning The Battery And Terminals

1. Park the power unit on a level surface.
2. Engage the parking brake and shut off the engine.
3. Remove the key from the ignition switch.
4. Open the left hood panel.
5. Disconnect and remove the battery.
6. Wash the battery with a solution of four table-spoons of baking soda to 1 gallon (3.8 L) of water. Be careful not to get the soda solution into the cell.
7. Rinse the battery with clean water and dry.
8. Clean the battery posts and battery cable terminals with a wire brush.
9. Install the battery back into the power unit.
10. Apply dielectric grease to the battery terminals to prevent corrosion.
11. Place the covers back over the battery terminals.
12. Close the left hood panel.

Charging The Battery

⚠ DANGER

Batteries produce explosive gases. Charge the battery in a well ventilated space where the gases produced by charging can dissipate. Do not charge where the battery could be exposed to sparks, open flames, or other sources of ignition.

Never charge a frozen battery, as it may explode. Allow the battery to warm up and inspect for cracks or damage before charging.

To preserve optimum battery performance and life, do not allow the battery to stand in a discharged state for long periods of time. If the battery is not being used, check the battery voltage every 30 days and recharge the battery if the voltage drops to 12.4 volts or lower.

Keep the battery fully charged in cold weather to prevent damage due to freezing.

1. If possible, remove the battery from the power unit before charging.
2. Refer to the battery charger's manual for specific charging instructions.
3. If electrolyte is expelled or excessive gassing occurs, or if the temperature of the battery exceeds 125° F (52° C), charging must be temporarily stopped to permit cooling. After cooling, reduce the charging rate before starting the charger again.

Jump Starting Procedure

⚠ DANGER

The battery produces a flammable and explosive gas. The battery may explode.

- Wear eye protection and gloves.
- Do not jump start a cold or frozen battery. Allow the battery to warm up and inspect for cracks or damage.
- Do not jump start a cracked or damaged battery.
- Do not attempt to jump start the power unit using a battery of a different voltage.

1. Inspect the discharged battery for terminal corrosion and loose connections. Clean terminals and tighten connections prior to jump starting.
2. Make sure the vehicle used to jump start the power unit has a 12 volt, negative ground, electrical system.
3. Pull the boosting vehicle up close to the disabled power unit. Be sure the vehicles do not touch.
4. Shut off the boosting vehicle's engine and set the parking brake.

⚠ CAUTION

Attempting to start the disabled unit with the boosting vehicle's engine running could cause damage to the regulator.

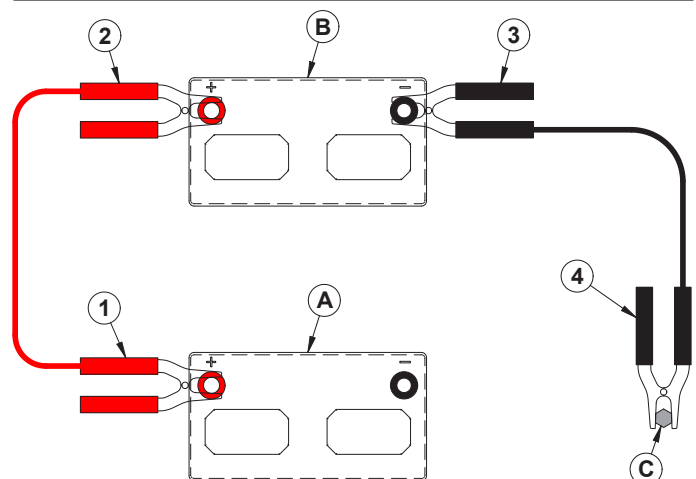

- A. Discharged Battery
 - B. Booster Battery
 - C. Ground Stud
5. Connect one end of the positive (+) booster cable to the discharged battery's positive (+) terminal (1).
 6. Connect the other end of the positive (+) booster cable to the booster battery's positive (+) terminal (2).

SERVICE

7. Connect the negative (-) booster cable to the booster battery's negative (-) terminal (3).
8. Connect the other end of the negative (-) booster cable to the disabled power unit's ground stud (4).
9. Start the disabled power unit and remove the booster cables in reverse order of installation (negative booster cable first).

TCM (Tractor Control Module) Explanation

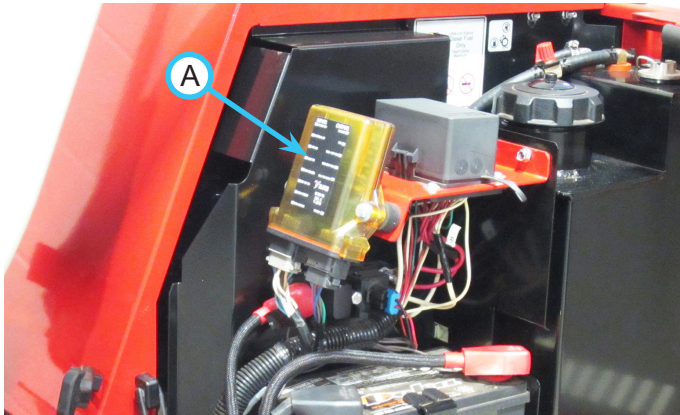

The Tractor Control Module (A) is a sealed computerized device designed to control the electronic safety related functions of this tractor. Both solid state and mechanical components are used to assure safe, reliable operation of this machine.

This TCM monitors the electronic circuits necessary for the engine, starter, and PTO to function. These "input" circuits include the PTO Switch, Neutral Switch, Parking Brake Switch, Key Switch, Seat Switch, and Generator Presence. The TCM is programmed to allow the engine, starter, or PTO to operate only when specific input criteria are satisfied. The engine, start, and PTO are controlled by "outputs" from the TCM. For additional information, refer to the TCM section of the troubleshooting guide.

Replacing Fuses (Power Relay Module)

1. Park the power unit on a level surface.
2. Engage the parking brake and shut off the engine.
3. Remove the key from the ignition switch.
4. Turn the battery disconnect switch to the Off position.
5. Open the left hood panel.
6. Remove the sealed fuse cap from the power relay module.
7. Identify and pull the defective fuse from the socket.

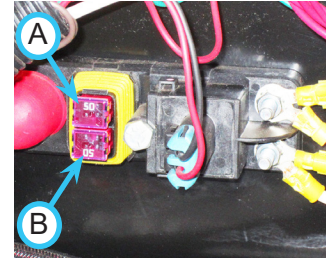

Power Relay module (J-Case Fuse)		
Position	Fuse	Circuit
Top (A)	50 amp	Rear Fuse Panel Supply
Bottom (B)	50 amp	Key Switch, TCM

8. Insert a new fuse into the socket. Be certain to use the correct amperage fuse or damage may occur to the power unit.
9. Reinstall the sealed fuse cap and close the left hood panel.
10. Turn the battery disconnect switch to the On position.

Replacing Fuses (Front Fuse Panel)

1. Park the power unit on a level surface.
2. Engage the parking brake and shut off the engine.
3. Remove the key from the ignition switch.
4. Turn the battery disconnect switch to the Off position.
5. Tilt the seat forward and remove the front canvas.
6. Remove the sealed cover (A) from the fuse panel.
7. Identify and pull the defective fuse from the socket.

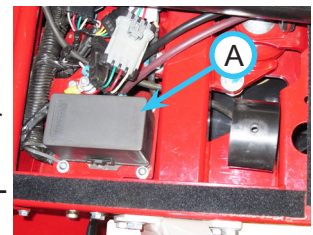

Front Fuse Panel (Mini Fuse)		
Position	Fuse	Circuit
1	15 amp	PTO
2	5 amp	Gauges & Alarm
3	5 amp	Seat Switch
4	15 amp	Head / Tail Lights
5*	20 amp	12v Rear
6*	15 amp	Work / Strobe Lights
7*	10 amp	Back-up / Horn / Directional
8*	15 amp	12v Front Relays
9*	5 amp	12v Front Controls
10*	10 amp	Hydraulic Auxiliary

*Optional accessory.

SERVICE

8. Insert a new fuse into the socket. Be certain to use the correct amperage fuse or damage may occur to the power unit.
9. Reinstall the sealed cover onto the fuse panel.
10. Reinstall the front canvas and lower the seat back down to the operating position.
11. Turn the battery disconnect switch to the On position.

Replacing Fuses (Rear Fuse Panel)

1. Park the power unit on a level surface.
2. Engage the parking brake and shut off the engine.
3. Remove the key from the ignition switch.
4. Turn the battery disconnect switch to the Off position.
5. Open the left hood panel.
6. Remove the sealed cover (A) from the fuse panel.
7. Identify and pull the defective fuse from the socket.

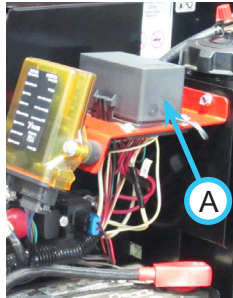

Rear Fuse Panel (Mini Fuse)		
Position	Fuse	Circuit
1*	25 amp (CB)	Spreader
2*	30 amp (CB)	Cab
3	10 amp	Fuel Pump
4	10 amp	Diesel Stop
5	5 amp	Engine Run
6	5 amp	Speedometer
7	20 amp	Starter Relay
8*	10 amp	Spreader Vibrator
9	5 amp	Tractor Control Module 1
10	15 amp	Tractor Control Module 2

*Optional accessory.

8. Insert a new fuse into the socket. Be certain to use the correct amperage fuse or damage may occur to the power unit.
9. Reinstall the sealed cover onto the fuse panel and close the left hood panel.
10. Turn the battery disconnect switch to the On position.

Replacing Fuses (Engine)

1. Park the power unit on a level surface.
2. Engage the parking brake and shut off the engine.
3. Remove the key from the ignition switch and allow the engine to cool.
4. Turn the battery disconnect switch to the Off position.
5. Open the right hood panel and remove the top hood panel to access the engine compartment.
6. **(Fuse Link)** Remove fuse link (A) from starter and alternator and install new fuse link.
7. **(J-Case Fuse)** Locate the fuse holder (B) and pull up on the tab to remove the cover.

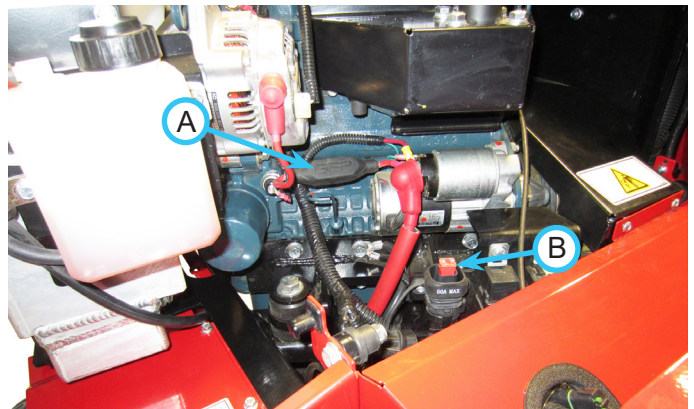

Engine Fuses		
Position	Fuse	Circuit
A	80 amp fuse link	Charge
B	50 amp J-Case	Glow Plug

8. Pull the defective fuse from the socket.
9. Insert a new fuse into the socket. Be certain to use the correct amperage fuse or damage may occur to the power unit.
10. Reinstall the fuse cover.
11. Replace the top hood panel and close the right hood panel.
12. Turn the battery disconnect switch to the On position.

SERVICE

Switching Speedometer (MPH or Km/H)

1. Park the power unit on a level surface.
2. Engage the parking brake, shut off the engine, and remove the key from the ignition switch.
3. Remove the steering column cover to access the wiring for the gauges. Follow the harness from the fuel cluster gauge to locate the green wire (labeled A-013) with the single plug.
4. For speedometer readout in miles per hour, the green wire (A-013) should be connected to the wire from the gauge labeled A-020.
5. For speedometer readout in kilometers per hour, the green wire (A-013) should be connected to the wire from the gauge labeled A-021.

Replacing Light Bulbs (Headlights)

⚠ CAUTION

The light bulb contains gases under pressure. The bulb may shatter if the glass is scratched or dropped. Wear eye protection and handle bulb with care.

1. Park the power unit on a level surface.
2. Engage the parking brake and shut off the engine.
3. Remove the key from the ignition switch.
4. Remove the two screws (A) from the light cover and remove the cover.

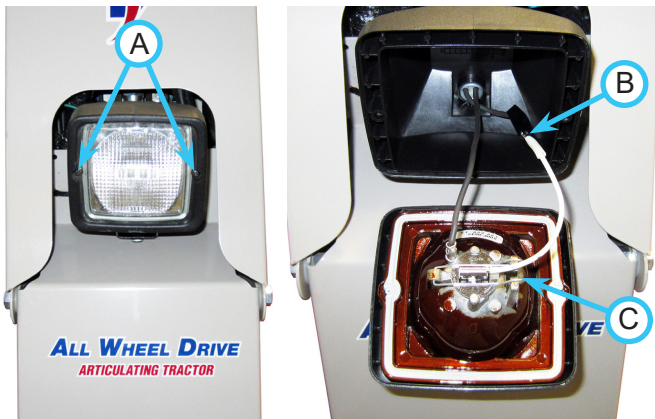

5. Disconnect the light bulb wire from the plug (B).
6. Pinch the wire spring fastener (C) and lift away from the light bulb.
7. Remove the defective light bulb.
8. Install the new light bulb and secure with the wire spring fastener.
9. Connect the light bulb wire to the plug.
10. Reinstall the light cover.

Replacing The Taillights

The taillights are equipped with LEDs and do not use a replaceable bulb. If a taillight no longer functions, the entire taillight must be replaced.

Replacing the Work Lights

The work lights are equipped with LEDs and do not use a replaceable bulb. If a work light no longer functions, the entire work light must be replaced.

Replacing The Turn Signal Lights

The signal lights used for the turn signal / hazard flasher kit are equipped with LEDs and do not use a replaceable bulb. If a signal light no longer functions, the entire light must be replaced.

Replacing The Strobe Light Bulb

1. Park the power unit on a level surface.
2. Engage the parking brake and shut off the engine.
3. Remove the key from the ignition switch.

⚠ WARNING

High Voltage!

Before removing strobe light lens, turn off power and wait five minutes for the capacitor to discharge.

4. Turn the battery disconnect switch to the Off position and wait five minutes for the capacitor to discharge.
5. Unscrew the strobe lens (A) from the base.
6. Hold the circuit board (B) in place with one hand and remove the strobe bulb (C).
7. Install the new strobe bulb, pushing it securely onto the circuit board connectors.
8. Ensure the circuit board and the o-ring are in place and reinstall the strobe lens.
9. Turn the battery disconnect switch to the On position.

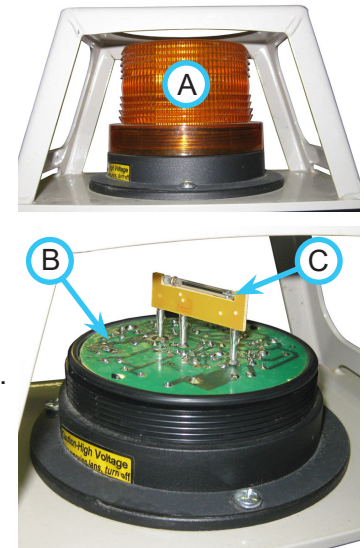

SERVICE

Drive Belt Inspection

⚠ WARNING

Always set the parking brake, shut off power unit engine, remove the ignition key, and ensure all moving parts have come to a complete stop before inspecting components or attempting any repair or adjustment.

Inspecting the belts of this power unit can prevent sudden belt failure by finding problems before they cause the belt to break. Inspect the belts prior to operation, as part of the daily inspection or anytime a problem is suspected. There may be a belt problem if there is a squealing or chattering sound, or the smell of a slipping belt.

The drive belts that are used on this power unit are shown below: the engine drive belt (A), the rear transaxle drive belt (B), the front transaxle drive belt (C), and the PTO drive belt (D).

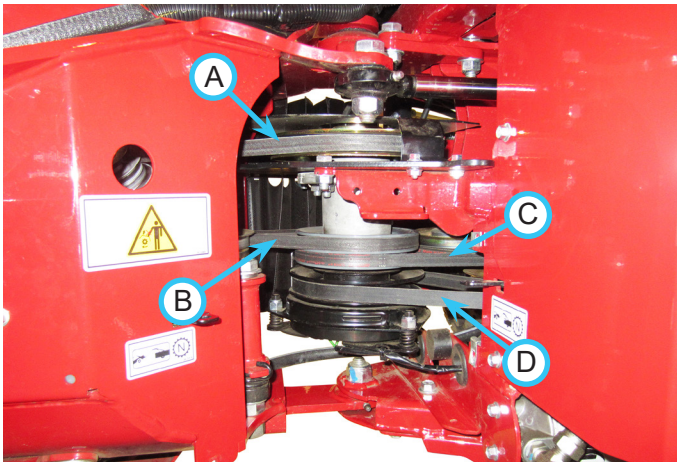

Typical wear on a drive belt may result in the conditions shown in the diagram. If any of these conditions occur, the drive belt will require replacement.

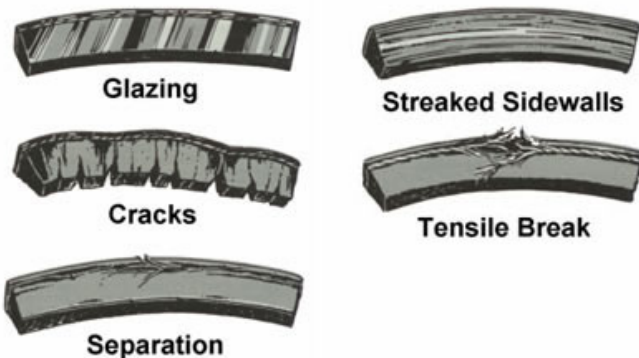

Engine Drive Belt Inspection & Adjustment

Due to the importance of the engine drive belt being properly aligned, this belt should be inspected for proper adjustment every 50 hours.

1. Park the power unit on a level surface.
2. Engage the parking brake and shut off the engine.
3. Remove the key from the ignition switch and allow the engine to cool.
4. Remove both center pivot canvas pieces.
5. Remove the top center pivot shield.
6. Make sure the power unit is pointed straight ahead, not turned to the left or right.
7. At the left side of the center drive pulley, the engine drive belt (A) should be angled approximately four degrees up away from the center spindle mount (B). Measure the vertical distance between the top of the center spindle mount and the bottom of the belt, where the belt crosses the rear edge of the center spindle mount. This distance should be between .719" (18.3 mm) and .781" (19.8 mm)

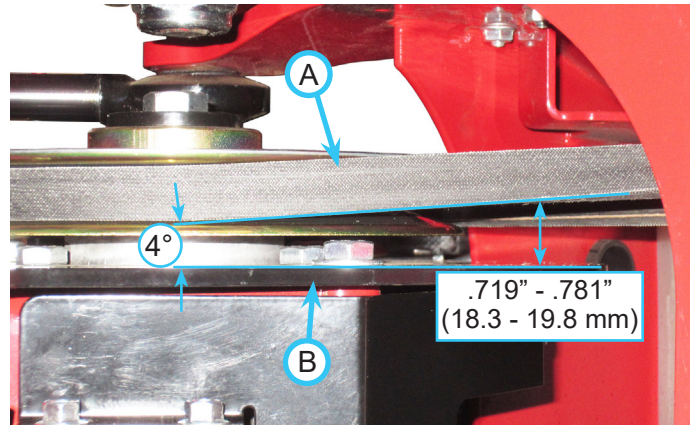

8. If the measurement is less than .719" (18.3 mm), the engine frame will need to be moved backward in the rear main frame. If the measurement is greater than .781" (19.8 mm), the engine frame will need to be moved forward in the rear main frame.
9. To adjust the engine frame position, loosen the 4) bolts that fasten the engine frame to the rear main frame. Note: the left rear engine frame bolt can be accessed under the rear frame just in front of the fuel tank with a socket and extension.

SERVICE

- Loosen the locking nut (C) on the adjustment bolt (D) at the left rear corner of the rear frame and turn the adjustment bolt clockwise to move the engine frame toward the rear of the main frame or turn the adjustment bolt counterclockwise to move the engine frame toward the front of the main frame.

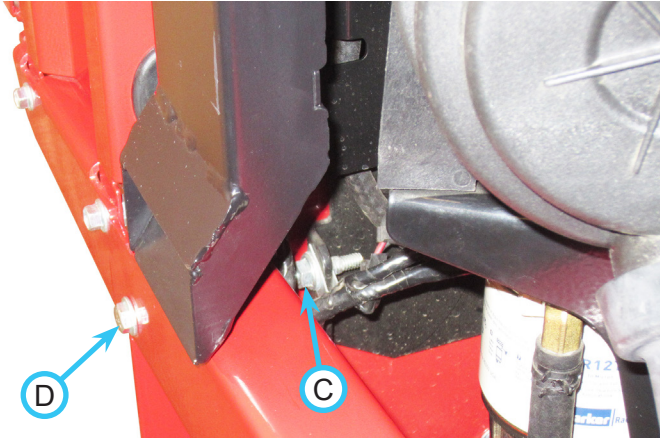

- Once the engine frame has been properly adjusted to achieve the correct drive belt alignment, torque the 4) bolts that fasten the engine frame to the rear main frame to 31 ft-lbs (42 Nm).
- Tighten the locking nut on the engine frame adjustment bolt.
- Install the top center pivot shield.
- Install both center pivot canvas pieces.

Engine Drive Belt Replacement

- Park the power unit on a level surface.
- Engage the parking brake and shut off the engine.
- Remove the key from the ignition switch and allow the engine to cool.
- Open the left hood panel and remove the top hood panel to access the engine compartment.
- Remove both center pivot canvas pieces.
- Remove the top center pivot shield.
- Remove the engine drive belt cover.

⚠ CAUTION

Spring may be under high tension. Use caution when removing belt, to prevent pinching fingers.

- Insert a 1/2" drive ratchet into the square cutout in the end of the idler arm and rotate the idler arm to release tension on the drive belt.
- Remove the engine drive belt from the engine, idler, and center shaft pulleys.
- Install the new drive belt as shown and engage the drive belt spring tensioner.

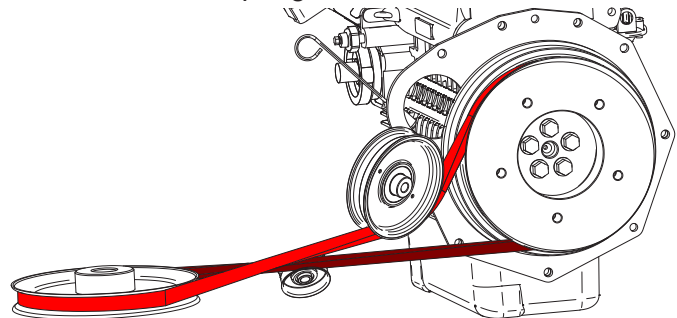

- Check to ensure the belt is properly seated in the pulleys.
- When installing a new drive belt, verify the belt alignment as directed in the Engine Drive Belt Inspection & Adjustment section of the manual.
- Install the engine drive belt cover.
- Install the top center pivot shield.
- Install both center pivot canvas pieces.
- Replace the top hood panel and close the left hood panel.

PTO Belt Replacement

- Park the power unit on a level surface.
- Engage the parking brake and shut off the engine.
- Remove the key from the ignition switch and allow the engine to cool.
- Remove both center pivot canvas pieces.
- Remove the left and right center pivot guards.

SERVICE

6. Remove the SDLA access cover.
7. Remove the tunnel access cover.
8. Disconnect the PTO clutch wire (A) and pull the plug out of the front frame.

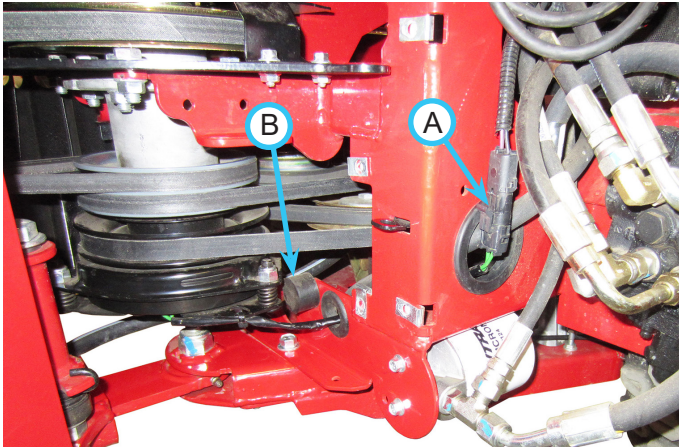

9. Remove the two rubber bumpers (B) from the front frame (one on each side of the PTO clutch).

⚠ CAUTION

Spring may be under high tension. Use caution when releasing spring, to prevent pinching fingers.

10. Release both arms of the PTO belt spring tensioner (C) located to the inside of the right front tire.

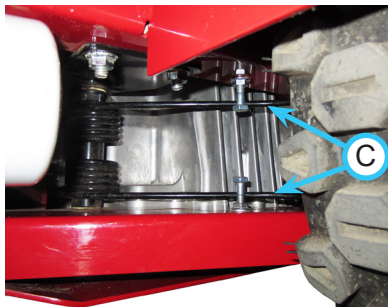

11. Remove the belt from the front double idler pulley, the PTO clutch, and the idler pulleys.
12. Install the new belt onto the PTO clutch, the idler pulleys, and then the front double idler pulley. Engage the PTO belt spring tensioner.

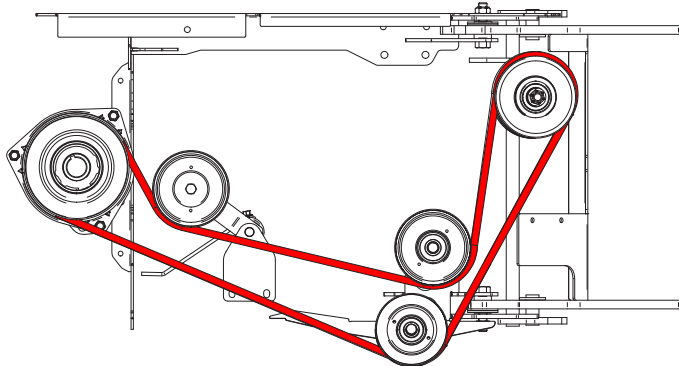

13. Check to ensure the belt is properly seated in the pulleys.

14. Install the 2) rubber bumpers onto the front frame.
15. Route the PTO clutch wire through the front frame openings and connect to the wire harness.
16. Install the tunnel access cover.
17. Install the SDLA access cover.
18. Install the left and right center pivot guards.
19. Install both center pivot canvas pieces.

Transaxle Drive Belt Replacement

Note: It is recommended that both the front and rear transaxle drive belts be changed at the same time. The transaxle belts will experience similar wear, and the same steps apply to changing both belts.

1. Park the power unit on a level surface.
2. Engage the parking brake and shut off the engine.
3. Remove the key from the ignition switch and allow the engine to cool.
4. Follow the steps in the PTO Belt Replacement section to remove the PTO belt from the PTO clutch. Note: it is not necessary to completely remove the PTO belt from the power unit.

⚠ CAUTION

Spring may be under high tension. Use caution when releasing spring, to prevent pinching fingers.

5. Locate the idler pulley assembly that tensions each transaxle drive belt and carefully unhook the spring arm from the power unit.
6. Remove both the front and rear transaxle drive belts from the power unit.
7. Install the rear transaxle drive belt, making sure the belt is properly seated in the both the transaxle and center pulleys, and engage the belt spring tensioner.
8. Install the front transaxle drive belt, making sure the belt is properly seated in the both the transaxle and center pulleys, and engage the belt spring tensioner.

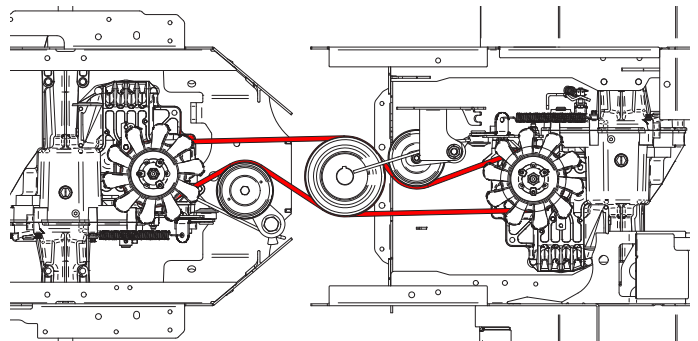

9. Follow the steps in the PTO Belt Replacement section to install the PTO belt onto the PTO clutch.

SERVICE

Clutch Air Gap Inspection & Adjustment

The electric clutch is activated by the PTO switch to engage or disengage power to belt driven attachments. The clutch also provides braking action to stop the attachment when the PTO is disengaged or the operator presence circuit is interrupted.

For proper operation, the air gap between the armature and the rotor must be set at .020" (.5 mm). If the air gap is too narrow, the clutch armature may drag when disengaged, causing premature failure. If the air gap is too wide, the clutch may not engage correctly or it may disengage when it becomes hot.

Check the air gap annually and adjust the clutch air gap as necessary.

1. Locate the three inspection windows (A) on the clutch.

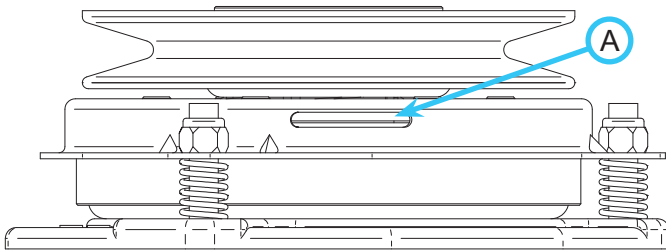

2. Place a .020" (.5 mm) feeler gauge in the slot between the armature and the rotor.

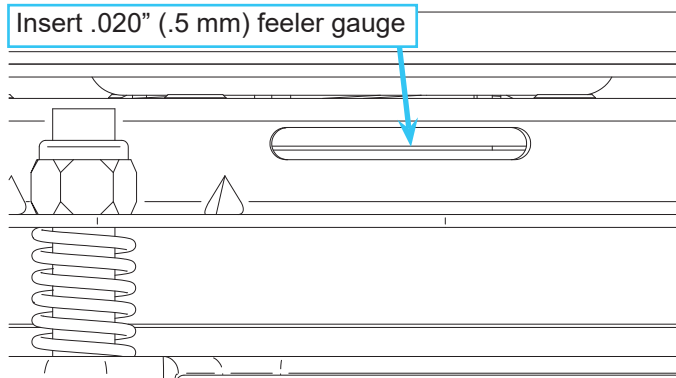

3. Tighten or loosen the clutch adjustment nut (B) as needed to achieve the .020" (.5 mm) air gap.

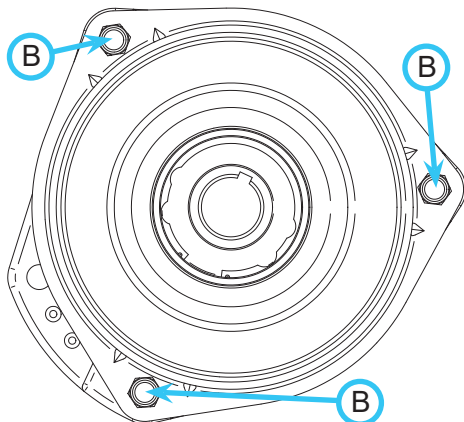

Wheel Removal & Installation

Wheel Removal:

1. Park the power unit on a level surface.
2. Engage the parking brake and shut off the engine.
3. Remove the key from the ignition switch.

⚠ WARNING

If power unit is not adequately supported, the unit could accidentally fall and trap or crush a person or appendage, causing severe injury or death.

4. Loosen the wheel lug nuts, but do not remove.
5. Lift up the corner of the power unit and secure with a jack stand.
6. Remove the lug nuts and lift the wheel off the mounting studs.

Wheel Installation:

1. Place the wheel onto the mounting studs with the hub side of the rim against the axle hub.
NOTE: the valve stem will be to the outside of the power unit.
2. Install the lug nuts and tighten by hand until the wheel is held against the axle hub.
3. Lift the power unit up slightly and remove the jack stand. Lower the power unit to the ground.
4. Tighten the wheel nuts in a crisscross sequence as shown. Torque to 85 ft-lbs (115 Nm).

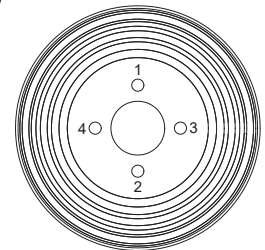

Tire Pressure

Check the tire pressure prior to operation, as part of the daily inspection. Keep tires evenly inflated. Keep tire inflation within the proper range to prevent premature wear and/or poor traction.

Tire Type	Without Cab	With Cab
All Terrain	9-12 psi (62-83 kPa)	16-20 psi (110-138 kPa)
Turf	9-12 psi (62-83 kPa)	16-20 psi (110-138 kPa)

SERVICE

ROPS And Seat Belt Inspection

⚠ WARNING

Failure to inspect and maintain the Roll-Over Protection System (ROPS) and seat belt can lead to serious injury or death.

If any part of the ROPS experiences structural damage, the entire ROPS must be replaced.

Inspect the roll bar and seat belt prior to operation, as part of the daily inspection.

1. Inspect the roll bar for damage, missing components, and loose or missing hardware. Replace any damaged or missing components and tighten loose hardware prior to operating the power unit.
2. Inspect the seat belt webbing for cuts, abrasions, fraying, or excessive wear.
3. Inspect the seat belt webbing for damage from exposure to the sun's ultraviolet rays. If the original color of the webbing is extremely faded, the physical strength of the webbing may be deteriorated.
4. Inspect the seat belt webbing for dust and dirt. If the webbing is packed with dirt, the physical strength of the webbing may be deteriorated.
5. Inspect the seat belt webbing for stiffness. If the webbing is no longer flexible, the physical strength of the webbing may be deteriorated.
6. Inspect the seat belt buckle and latch for damage, cracks, or excessive wear.
7. Inspect the seat belt for proper operation. The seat belt should latch securely and release smoothly. Seat belt adjustment should be accomplished without excessive resistance.

If any problems are detected during this inspection, the component must be replaced prior to operating the power unit.

Parking Brake Inspection & Adjustment

The parking brake tension must be set between a minimum of 15 pounds (7 kg) and a maximum of 22 pounds (10 kg) of force required to engage the selector lever into the park brake position. If the force required to engage the selector lever into the park position is not within this range, or if engaging the park brake will not prevent the power unit from moving, the brake will need to be adjusted.

1. Park the power unit on a level surface.
2. Shut off the engine and remove the key from the ignition switch.

⚠ WARNING

The parking brake must be disengaged as part of the adjustment procedure. Park the power unit on a level surface and place wheel chocks in front and back of wheels to prevent the power unit from rolling forward or backward.

3. Place wheel chocks in front and back of wheels to prevent power unit from rolling.

⚠ WARNING

If power unit is not adequately supported, the unit could accidentally fall and trap or crush a person or appendage, causing severe injury or death.

4. Lift the left front corner of the power unit so the left front tire is off the ground and secure the power unit with a jack stand or supporting block.
5. Remove the left front tire to provide easier access to the brake adjustment castle nut.
6. Place the selector lever in the Neutral Assist Off position.
7. Remove the cotter pin from the brake adjustment castle nut (A).

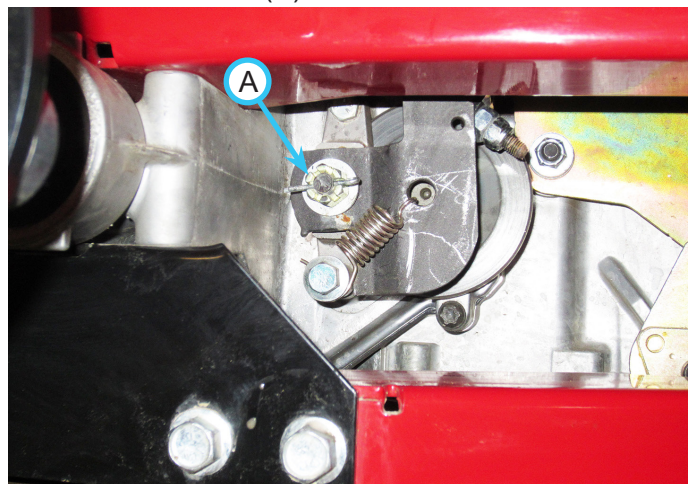

SERVICE

8. If the amount of force required to engage the selector lever into the park position was less than 15 pounds (7 kg), turn the castle nut tighter by one position. If the amount of force required to engage the selector lever into the park position was greater than 22 pounds (10 kg), loosen the castle nut by one position.



Attention

Parking brake tension set to a force greater than the specified maximum will result in premature brake failure.

9. Insert the cotter pin to hold the castle nut in place and retest the force required to engage the selector lever into the park position. Continue adjusting the castle nut in one position increments until the required force is reached.
10. Once the correct force required to engage the selector lever into the park position is reached, bend the cotter pin so it will not work loose from the castle nut.
11. Place the selector lever in the Park position.
12. Reinstall the left front tire and torque the lug nuts to 85 ft-lbs (115 Nm).
13. Lower the power unit to the ground.

Neutral Adjustment

The power unit should come to a complete stop with the selector lever in the Neutral Assist Auto position. The power unit should not attempt to move with the parking brake engaged. If the power unit is attempting to move, there will be an excessive amount of noise from the transaxles.

If the power unit moves or attempts to move in either condition, the power unit must be taken to an authorized Ventrac dealer for neutral position adjustment.

Storage

1. Clean the power unit.



Attention

To maintain the finish of the power unit and attachment, thoroughly wash the equipment to remove any corrosive agents (e.g., salt). Failure to clean the equipment may result in corrosion of (including but not limited to) steel, aluminum, and electrical components.

2. Inspect for loose or missing hardware, damaged components, or signs of wear.
3. Inspect the ROPS structure and seat belt for damage or signs of wear..
4. Inspect safety decals. Replace any safety decals that are faded, illegible, or missing.
5. Inspect hydraulic hoses for leaks and/or wear. Service as required.
6. Inspect hydraulic hoses, hydraulic fittings, and fuel lines to ensure tight, leak free connections.
7. Ensure parking brake is properly adjusted.
8. Inspect electrical system and connections.
9. Test the operator safety interlock system.
10. Perform a TCM (tractor control module) check to make sure the inputs and outputs are correct. Refer to the troubleshooting section for input and output information.
11. Inspect the PTO pulley and belt for damage or excessive wear. Service as required.
12. Inspect the electric PTO clutch air gap. Set gap to .020" (.5 mm).
13. Check the hydraulic oil level. Add fluid or service as required.
14. Check the coolant level and make sure the temperature protection range is at least -34° F (-37° C). Add fluid or service as required.
15. Ensure the radiator screen, air cleaner, and engine compartment are clean.
16. Check tires for proper inflation.
17. Grease and lubricate all points specified in the maintenance section. Wipe off any excess grease or oil.

After all the above steps have been performed, complete the preparation for storage by performing the steps for either long term storage (4 months or longer) or short term storage (less than 4 months).

SERVICE

Long Term Storage (4 Months or Longer)

1. Change the engine oil to prevent damage that can be caused by acidic build up in used motor oil.
2. Add a quality diesel fuel treatment to the fuel tank. Follow the manufacturer's recommended mixing ratios. Start the power unit's engine and run for 10 minutes to allow the fuel treatment to travel all through the fuel system.
3. Turn the key to the off position and remove.
4. Engage the parking brake.
5. Turn the fuel shut-off valve to the Off position.
6. Turn the battery disconnect to the Off position.
7. If the power unit is being stored in a cold climate (below 35° F (2° C)), remove the battery from the power unit and store in a warm location. Check the battery charge level periodically and charge the battery, if necessary.

Short Term Storage (Less than 4 Months)

1. Add a quality diesel fuel treatment to the fuel tank. Follow the manufacturer's recommended mixing ratios. Start the power unit's engine and run for 10 minutes to allow the fuel treatment to travel all through the fuel system.
2. Turn off the power unit engine and remove the key.
3. Engage the parking brake.
4. Turn the fuel shut-off valve to the Off position.
5. Turn the battery disconnect to the Off position.
6. Check the battery charge level periodically and charge the battery, if necessary.

Removing the Power Unit from Storage

1. Inspect, clean, and prepare the power unit for use. Perform all the steps in the daily inspection prior to use.

SERVICE

Maintenance Schedule

Maintenance Schedule	# of Locations	# of Pumps	AS NEEDED	After First 50 Hrs.	Daily	At 50 Hours	At 100 Hours	At 150 Hours	At 200 Hours	At 250 Hours	At 300 Hours	At 350 Hours	At 400 Hours	At 450 Hours	At 500 Hours	At 550 Hours	At 600 Hours	At 650 Hours	At 700 Hours	At 750 Hours	At 800 Hours	At 850 Hours	At 900 Hours	At 950 Hours	At 1000 Hours	Yearly	1500 Hours ^{**}		
																												Grease & Lubrication: See Lubrication Section	
Lift Cylinder	2	1	✓			✓	✓	✓	✓	✓	✓	✓	✓	✓	✓	✓	✓	✓	✓	✓	✓	✓	✓	✓	✓	✓	✓	✓	
Center Pivot	1	1	✓			✓	✓	✓	✓	✓	✓	✓	✓	✓	✓	✓	✓	✓	✓	✓	✓	✓	✓	✓	✓	✓	✓	✓	
Steering Cylinder	2	1	✓			✓	✓	✓	✓	✓	✓	✓	✓	✓	✓	✓	✓	✓	✓	✓	✓	✓	✓	✓	✓	✓	✓	✓	
Lower Connector Link	2	1	✓			✓	✓	✓	✓	✓	✓	✓	✓	✓	✓	✓	✓	✓	✓	✓	✓	✓	✓	✓	✓	✓	✓	✓	
Seat Slide	2	#	✓			✓	✓	✓	✓	✓	✓	✓	✓	✓	✓	✓	✓	✓	✓	✓	✓	✓	✓	✓	✓	✓	✓	✓	
Engine [†]																													
Check Engine Oil Level				✓																									
Change Engine Oil & Filter [†]			✓			✓		✓		✓		✓		✓		✓		✓		✓		✓		✓		✓		✓	
Inspect Air Filter Restriction Gauge				✓																									
Replace Primary Air Filter			**			**		✓		**		✓		**		✓		**		✓		**		✓		**		✓	
Replace Safety Air Filter												✓										✓							
Check Coolant Level				✓																									
Service Cooling System																												✓	
Clean Engine Compartment, Engine, & Radiator			**	✓																									
Replace Fuel Filter			✓									✓										✓							
Drain Water & Sediment from Fuel Tank			✓																									✓	
Hydraulic System																													
Check Hydraulic Oil Level				✓																									
Change Hydraulic Filter ^{**}						✓								✓															✓
Change Hydraulic Oil and Rear Transaxle Oil ^{**}														✓															✓
Parking Brake																													
Parking Brake Inspection & Adjustment				✓																									
Electrical																													
Replace Light Bulbs			✓																										
Clean Battery Terminals & Compartment			✓																										✓
Inspection																													
Inspect Operator Interlock System				✓																									
Inspect ROPS structure and seatbelt				✓																									
Inspect for Loose, Missing, or Worn Components				✓																									
Inspect Battery, Electrical Connections, and Lights				✓																									
Inspect Belts, Fuel Lines, and Hydraulic Lines				✓																									
Check Tire Pressure.				✓																									
Inspect Engine Drive Belt Adjustment				✓	✓	✓	✓	✓	✓	✓	✓	✓	✓	✓	✓	✓	✓	✓	✓	✓	✓	✓	✓	✓	✓	✓	✓	✓	✓
Check Wheel Lug Nuts. Torque to 85 ft-lbs (115 Nm)				✓	✓					✓					✓						✓					✓			
Check Steering Cylinder Bolts. Torque to 150 ft-lbs (205 Nm)						✓		✓		✓		✓		✓		✓		✓		✓		✓		✓		✓		✓	
Check Front/Rear Connector Link Bolts. Torque to 150 ft-lbs (205 Nm)						✓		✓		✓		✓		✓		✓		✓		✓		✓		✓		✓		✓	
Check Front Hitch Pivot Bolts. Torque to 75 ft-lbs (102 Nm)						✓		✓		✓		✓		✓		✓		✓		✓		✓		✓		✓		✓	
** Operation in severe conditions may require more frequent service intervals.																													
† Consult Engine Owner's Manual for engine oil information and complete servicing information																													
# Silicon Based Spray Lubricant																													
% Hydraulic filters initial change @ 100 hours. Change oil and filters @ 500 hours, then every 1000 hours.																													

SERVICE

Maintenance Checklist

Maintenance Checklist	Grease & Lubrication: See Lubrication Section																										
	# of Locations	# of Pumps	AS NEEDED	After First 50 Hrs.	Daily	At 50 Hours	At 100 Hours	At 150 Hours	At 200 Hours	At 250 Hours	At 300 Hours	At 350 Hours	At 400 Hours	At 450 Hours	At 500 Hours	At 550 Hours	At 600 Hours	At 650 Hours	At 700 Hours	At 750 Hours	At 800 Hours	At 850 Hours	At 900 Hours	At 950 Hours	At 1000 Hours	Yearly	1500 Hours [%]
Lift Cylinder	2	1																									
Center Pivot	1	1																									
Steering Cylinder	2	1																									
Lower Connector Link	2	1																									
Seat Slide	2	#																									
Engine ¹																											
Check Engine Oil Level																											
Change Engine Oil & Filter ¹																											
Inspect Air Filter Restriction Gauge																											
Replace Primary Air Filter																											
Replace Safety Air Filter																											
Check Coolant Level																											
Service Cooling System																											
Clean Engine Compartment, Engine, & Radiator																											
Replace Fuel Filter																											
Drain Water & Sediment from Fuel Tank																											
Hydraulic System																											
Check Hydraulic Oil Level																											
Change Hydraulic Filter [%]																											
Change Hydraulic Oil and Rear Transaxle Oil [%]																											
Parking Brake																											
Parking Brake Inspection & Adjustment																											
Electrical																											
Replace Light Bulbs																											
Clean Battery Terminals & Compartment																											
Inspection																											
Inspect Operator Interlock System																											
Inspect ROPS structure and seatbelt																											
Inspect for Loose, Missing, or Worn Components																											
Inspect Battery, Electrical Connections, and Lights																											
Inspect Belts, Fuel Lines, and Hydraulic Lines																											
Check Tire Pressure.																											
Inspect Engine Drive Belt Adjustment																											
Check Wheel Lug Nuts. Torque to 85 ft-lbs (115 Nm)																											
Check Steering Cylinder Bolts. Torque to 150 ft-lbs (205 Nm)																											
Check Front/Rear Connector Link Bolts. Torque to 150 ft-lbs (205 Nm)																											
Check Front Hitch Pivot Bolts. Torque to 75 ft-lbs (102 Nm)																											
** Operation in severe conditions may require more frequent service intervals.																											
¹ Consult Engine Owner's Manual for engine oil information and complete servicing information																											
# Silicon Based Spray Lubricant																											
[%] Hydraulic filters initial change @ 100 hours. Change oil and filters @ 500 hours, then every 1000 hours.																											

SERVICE

Ventrac Maintenance Log

Model Number: _____

Serial Number:

-

Date:	Hours:	Description of Repairs/Service	Initials

SERVICE

Ventrac Maintenance Log

Date:	Hours:	Description of Repairs/Service	Initials

Blank Page

TROUBLESHOOTING

Wiring Diagram Reference Key

Wire Reference Key

Harness Section Identifier

A = 32.0130 - Harness, Front
B = 32.0131 - Harness, Rear
C = 32.0132 - Harness, Kubota Diesel
D = 32.0133 - Harness, B&S Engine
E =
F =
G = 32.0148 - Harness, Kit - 12v Front
H = 32.0156 - Harness, Kit - 12v Rear
J = 32.0151 - Harness, Kit - 12v Dual Hydraulic
K = 32.0150 - Harness, Kit - PTO Remote
L = 32.0152 - Harness, Kit - Horn
M = 32.0149 - Harness, Kit - Backup Alarm
N = 32.0155 - Harness, Kit - Directional
P = 32.0154 - Harness, Kit - Strobe Light
R = 32.0153 - Harness, Kit - Work Light

----- = *Black Wire
———— = White Wire
||| ——— = Ground
● = Splice or Connection

* All black wires that are part of the wire harness are part of the ground circuit. However, some components such as lights may be wired where black may be positive.

All other wires colors are as shown

Anything outlined with a blue box is a Standard Feature

Anything outlined with a Green box is a Option

Wire Color & Circuit Type

Black = Ground
Dark Blue = Pre-Heat
Lt Blue = Safety Circuit
Brown = Engine Run / Kill
Gray = 12v Aux / Horn power
Green = Start/Speed/Directional
Lt Green = 12 Aux
Orange = Propane / Slope
Pink = Alarm
Purple = PTO
Red = Power
Tan = RPM
White = Power
Yellow = Light/Directional

TROUBLESHOOTING

Wiring Diagram - Rear Harness

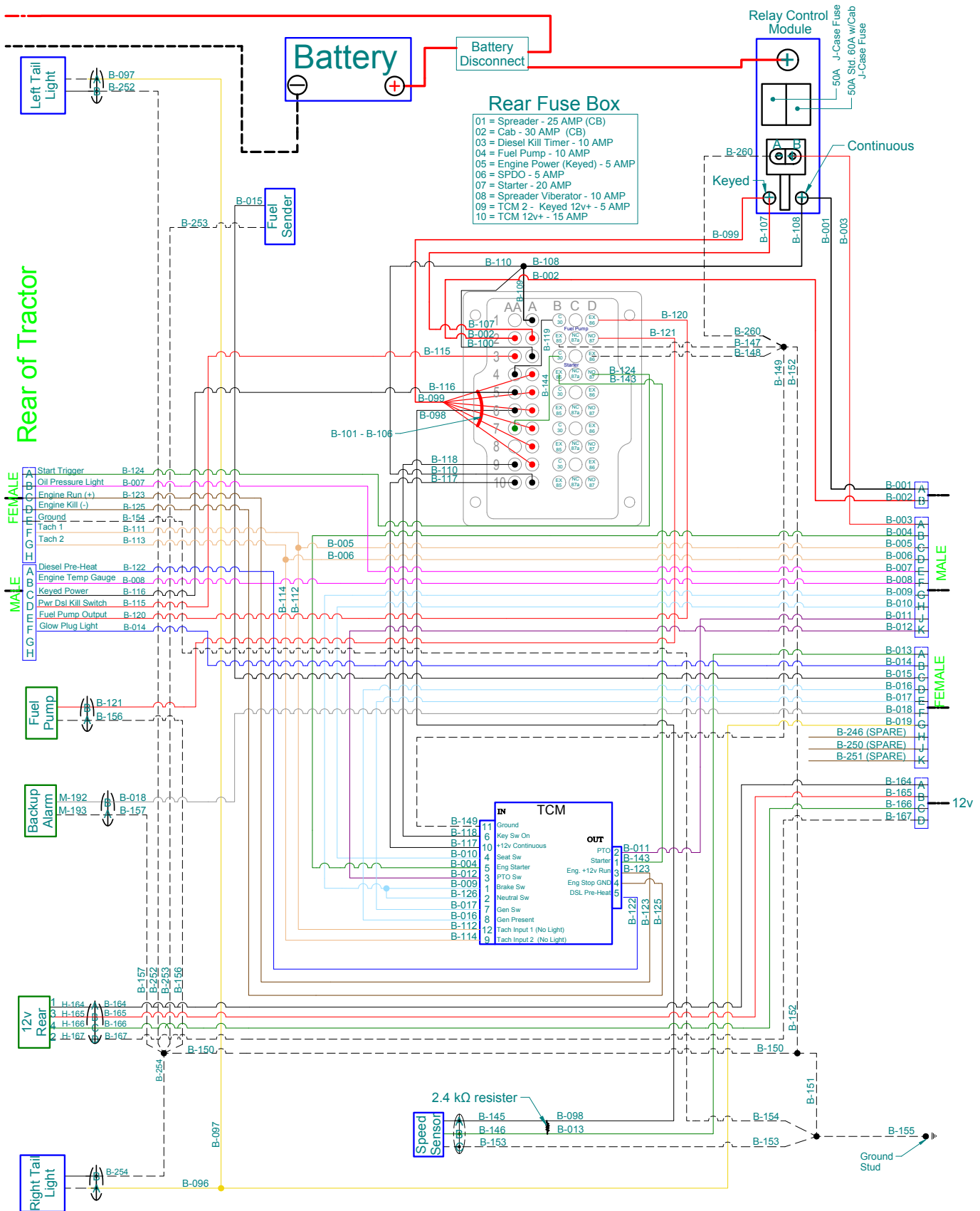

TROUBLESHOOTING

Wiring Diagram Engine Harness

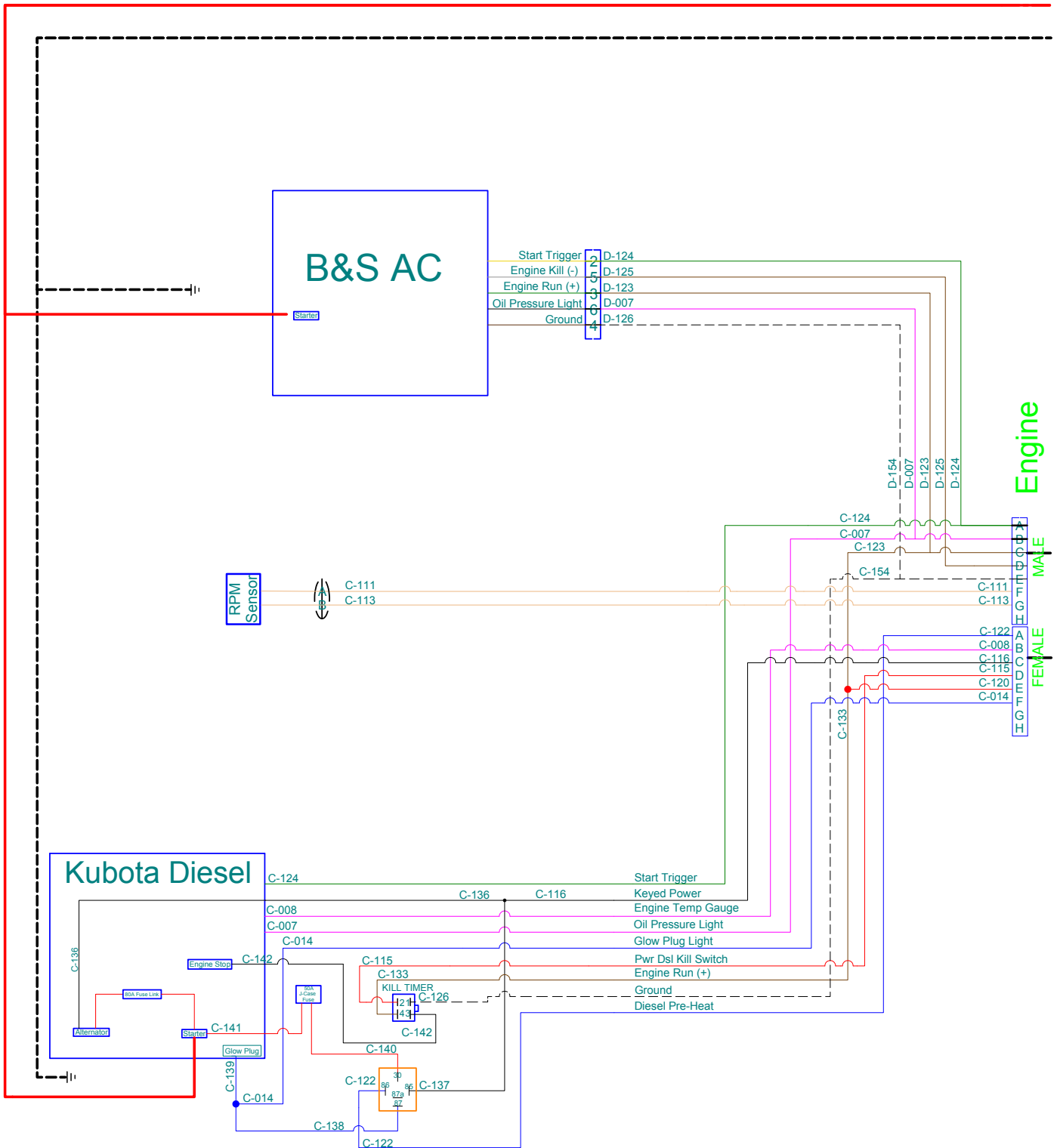

TROUBLESHOOTING

Wiring Diagram - Optional 30.0219 4-Pin Female Socket & 30.0218 4-Pin Male Plug



Attention

This connector (4-pin socket) is designed for use with Ventrac original equipment only. This connector (4-pin socket) is rated for 20 amp maximum current draw. Engine alternator and/or battery capacity determine allowable continuous draw.

30.0219 4-pin female socket is used in the 70.3036 12 Volt Front kit & 70.3050 12 Volt Rear Kit.

**Front View of Socket
Without Cover**

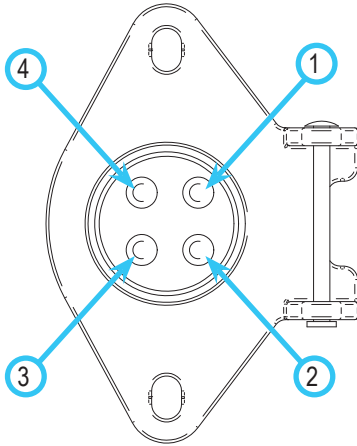

Rear View of Socket

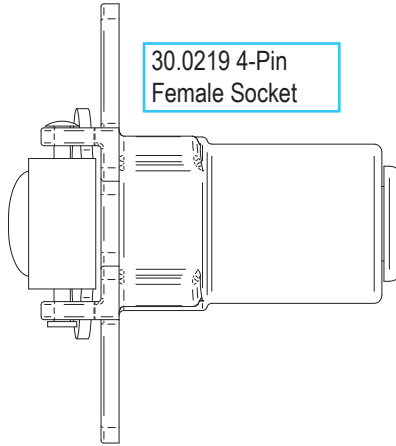
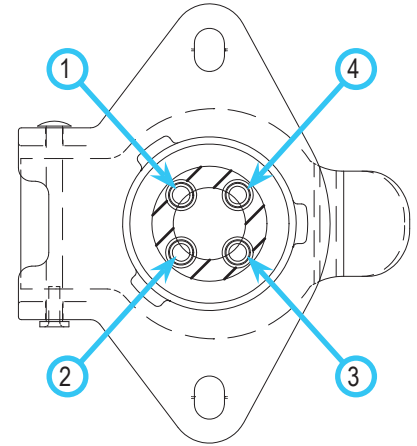

Terminal Position	Wire Color	Function
1	White	Positive (On/Off Switched)
2	Black	Negative (Constant)
3	Green or Brown	Positive/Negative (Momentary Switched Reversing)
4	Red	Positive/Negative (Momentary Switched Reversing)

30.0218 4-pin plug is used on attachments to connect to the 30.0219 socket on the power unit.

Front View of Plug

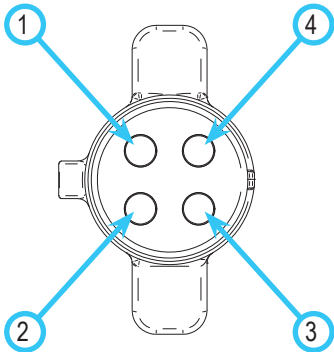

Rear View of Plug

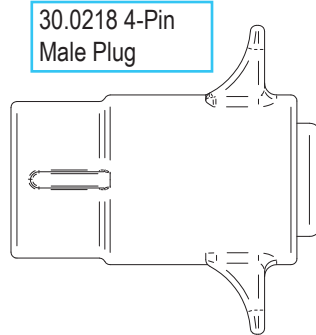
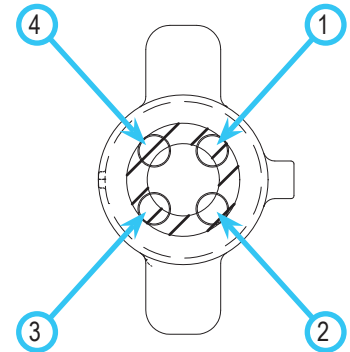

Terminal Position	Wire Color	Function
1	Not Specified*	Positive (On/Off Switched)
2	Not Specified*	Negative (Constant)
3	Not Specified*	Positive/Negative (Momentary Switched Reversing)
4	Not Specified*	Positive/Negative (Momentary Switched Reversing)

* Refer to the part diagram in the attachment's operator's manual for specific wire color and terminal position for each model.

TROUBLESHOOTING

Electrical Troubleshooting Using The Tractor Control Module (TCM)

The TCM monitors the electronic circuits necessary for the engine, starter, and PTO to function. These “input” circuits include the PTO Switch, Neutral Switch, Parking Brake Switch, Key Switch, Seat Switch, and Generator Presence. The TCM is programmed to allow the engine, starter, or PTO to operate only when specific input criteria are satisfied. The engine, start, and PTO circuits are controlled by “outputs” from the TCM.

For troubleshooting purposes, the TCM includes red LED lights for each circuit. The LED lights will activate when the input or output circuit is activated. The TCM is divided into two sections: the left (input) side displays the 8 inputs with red LED lights; the right (output) side displays the 5 outputs also with red LED lights. The TCM has two power supplies. The first supplies powers to the computer independent of the key switch so that the TCM does not turn on and off with each key switch on & off cycle. (Note: When the battery disconnect switch is turned to Off, the TCM is also turned off). The second supply energizes the rest of the computer when the key switch is turned on.

When the battery disconnect switch is turned on, the Power LED light (J) will illuminate. If the system voltage drops below a preset value when the key switch is off, or if the power unit sits unused for more than 15 days, the TCM will automatically go to ‘Sleep’ mode and enter a reduced power state. To ‘Wake’ the TCM, turn the battery disconnect switch off and then back on.

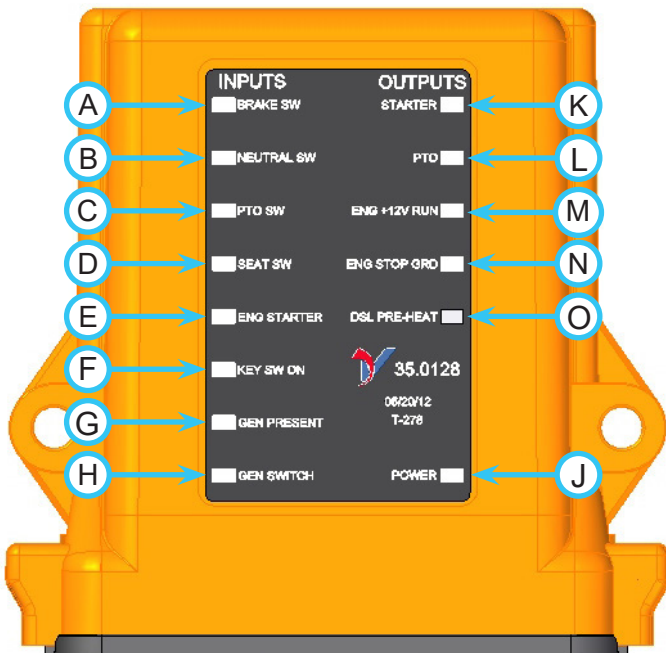

Input Circuits

Brake Switch (A)

The light indicates the circuit is closed and the parking brake is engaged. In order for this light to operate, the key switch must be in the On position.

Neutral Switch (B)

The light indicates the circuit is closed and the power unit’s forward/reverse control is in neutral. In order for this light to operate, the key switch must be in the On position and the forward/reverse control (SDLA) must be in the neutral position.

PTO Switch (C)

The light indicates the PTO switch is in the On position. In order for this light to operate, the key switch must be in the On position and the PTO switch must be in the On (engaged) position.

Seat Switch (D)

The light indicates that an operator is present in the seat. In order for this light to operate, the key switch must be in the On position and the operator must be present in the seat.

Engine Starter (E)

The light indicates that the key switch is turned to the Start position.

Key Switch On (F)

The light indicates that the key switch is turned to the On position. The key switch must be in the On position for the TCM to activate.

Generator Present (G)

The light indicates that the generator is connected to the power unit, which activates a specific set of criteria and allows the PTO to operate without an operator present on the seat. In order for this light to operate, the key switch must be in the On position and a generator must be connected to the power unit.

Generator Switch (H)

The light indicates that the switch on the generator is set to the On (engaged) position. In order for this light to operate, the key switch must be in the On position, a generator must be connected to the power unit, and the switch on the generator must be pulled up to the On (engaged) position.

Power (J)

This light is located at the bottom right corner of the TCM. This light indicates that there is full time power to the TCM and is only shut off by the battery disconnect switch or if the TCM enters the ‘Sleep’ mode. It keeps the TCM computer energized to eliminate the delay that would otherwise be present when the key switch is first turned to the On position.

TROUBLESHOOTING

Output Circuits

Specific input conditions must be satisfied before each output circuit can function.

Starter (K)

The light indicates that power is being sent to the starter solenoid. For the starter output to function, the parking brake must be set and the power unit's forward/reverse control must be in neutral.

PTO (L)

The light indicates that power is being sent to the PTO clutch relay. For the PTO output to function, the operator must be on the seat.

If the PTO remote kit is installed and an attachment such as the generator is connected, the TCM will automatically enable the Remote PTO function. In this mode the PTO switch on the generator replaces the seat switch criteria for the PTO to function. The parking brake must be engaged for the Remote PTO to function.

The following engine commands are engine specific.

Engine +12V Run (M)

This light indicates that power is being sent to the engine control module in order for the engine to run. For this light to operate, either the operator must be sitting on the seat, or the parking brake must be engaged and the forward/reverse control (SDLA) must be in the neutral position.

Engine Stop Ground (N)

Not used on the 3400Y.

Diesel Pre-Heat (O)

This output controls the signal that activates and deactivates the glow plugs.

TROUBLESHOOTING

Electrical Troubleshooting Guide

1. Always ensure that there is power supplied to the computer (TCM). With the key switch in the Off position, check to ensure the LED light for the Power input (J) is turned on. If the light is not on:
 - a. Check the battery disconnect switch to ensure it is turned on.
 - b. If the battery disconnect switch was already turned on, the TCM may be in 'Sleep' mode. Turn the battery disconnect switch off for 10 seconds and then back on to 'Wake' the TCM.
 - c. Check the 15 amp fuse in slot #10 of the rear fuse panel. Replace this fuse, if necessary.
2. Turn the key switch to the On position and check to see if any of the other lights turn on. If no other lights turn on, check the 5 amp fuse in slot #9 of the rear fuse panel. Replace this fuse, if necessary. If any other lights turn on, you can start troubleshooting the rest of the TCM functions.
3. To troubleshoot the circuits in the chart below, the corresponding LED lights must be 'On' for the circuit to function. If any of the required LED lights are not on, refer to the troubleshooting section in the following pages.

Circuit	Power	Brake Switch	Neutral Switch	PTO Switch	Seat Switch	Engine Starter	Key Switch
Starter							
PTO							
Engine +12V Run w/o Operator							
Engine +12V Run w/Operator							
Engine Stop Ground							
DSL Pre-Heat*						²	¹

* Diesel engines only

¹ Turns on when the key switch is turned to the Run position. Remains on for 6 seconds.

² Turns on when starter is engaged. Remains on for 5 seconds after the engine starts and the key switch is released and returns to the Run position.

TROUBLESHOOTING

Engine

Symptom:	Possible Cause:
Starter will not engage.	Battery disconnect switch in Off position. Tractor Control Module (TCM) is in 'Sleep' mode. Blown fuse in power relay module. Blown fuse in start circuit. Selector lever / parking brake is not in the park position. Parking brake switch is out of adjustment. Low battery voltage.
Engine cranks, but won't start.	Fuel shut-off valve is turned off. Insufficient fuel level. Faulty fuel pump. Plugged fuel filters. Cold weather - cycle glow plugs a second time. Glow plugs not working. Obstruction in the fuel line. Fuel shut-off solenoid not working. Faulty injector pump. Poor engine compression.
Engine runs rough.	Plugged or partially plugged air filters. Plugged or partially plugged fuel filters. Stale, dirty fuel OR wrong seasonal fuel mixture. Insufficient fuel level. Faulty fuel pump. Dirty or faulty fuel injectors. Faulty injector pump. Incorrect valve clearance. Valve seat failure.
Engine low on power.	Plugged or partially plugged air filters. Plugged or partially plugged fuel filters. Dirty or faulty fuel injectors. Low cylinder compression. Faulty injector pump.
Engine overheats.	Dirty radiator screen. Low coolant level. Debris in engine compartment. Defective radiator cap. Defective thermostat. Loose alternator fan belt. Blown head gasket.
Oil light comes on when running.	Low oil level. Faulty oil sender. Faulty or plugged oil pump.

TROUBLESHOOTING

Engine (Continued)

Symptom:	Possible Cause:
Engine emits white smoke.	Low engine temperature. Faulty head gasket. Water in combustion chamber.
Excessive fuel consumption.	Plugged or restricted air filters or hose. Dirty or faulty fuel injectors.
Engine uses excessive oil.	Check for leaks. Incorrect oil viscosity. Plugged or restricted air filters and or hose. Worn rings or cylinder walls. Worn or faulty valves.

Electrical

Anytime there is an electrical issue, first check to ensure the LED light for the Power input (bottom right corner) of the TCM is turned on when the key switch is in the Off position. If the light is not on:

- a. Check the battery disconnect switch to ensure it is turned on.
- b. If the battery disconnect switch was already turned on, the TCM may be in 'Sleep' mode. Turn the battery disconnect switch off for 10 seconds and then back on to 'Wake' the TCM.
- c. Check the 15 amp fuse in slot #10 of the rear fuse panel. Replace this fuse, if necessary.

Next, turn the key switch to the On position and check to see if any of the other lights turn on. If no other lights turn on, check the 5 amp fuse in slot #9 of the rear fuse panel. If any other lights turn on, you can start troubleshooting the rest of the TCM functions.

Symptom:	Possible Cause:
Battery does not charge.	Loose or corroded connections. Broken or loose wire in charge system. Blown fuse or fuse link in charge system. Defective battery. Loose alternator belt. Defective alternator.
Lights do not activate.	Blown fuse. Blown light bulb. Broken wire. Defective light switch.
Glow plugs do not activate.	Blown fuse. Broken wire. Faulty glow plugs.
PTO does not engage.	Blown fuse. Faulty seat switch. (Operator must be in seat). Faulty PTO switch. PTO belt failure. Clutch air gap out of adjustment. Faulty clutch.

TROUBLESHOOTING

Electrical (Continued)

Symptom:	Possible Cause:
All TCM lights are on, even with key switch off.	Low battery voltage.

Hydraulic

Symptom:	Possible Cause:
Front attachment does not lift.	Hydraulic oil level is low. Excessive load on front lift. Plugged hydraulic oil filter. Faulty hydraulic cylinder. Pump charge pressure is low. Hardware missing on lift cylinder. Hardware missing on SDLA lever links.
Steering is difficult.	Hydraulic oil level is low. Plugged hydraulic oil filter. Faulty steering cylinder. Pump charge pressure is low. Excessive load on hydraulic system.
Excessive noise in hydraulic system.	Hydraulic oil level is low. Plugged hydraulic oil filter. Wrong oil used in hydraulic system. Cold weather - allow power unit to warm up.
Hydraulic system overheats	Debris buildup around transaxle. Damaged transaxle cooling fan.

Power Unit

Symptom:	Possible Cause:
Power unit will not move with engine running.	Selector lever / parking brake is in park position. Transaxle neutral levers are disengaged for towing. Transaxle drive belt failure. Hydraulic oil level is low. Brake not releasing. Pump control connecting linkage loose or off.

SPECIFICATIONS

Engine

Manufacturer	Kubota
Model Number	D902
Type	Diesel
Cylinders	3
Displacement	898 cc
Engine Gross Power	22 Hp (16.4 kW)
Peak Torque	41 ft-lbs (55.6 Nm) @ 2600 rpm
Operating Range (RPM)	1600 - 2850
Cooling System	Liquid Cooled
Alternator60 Amp

Electrical

Battery	500 Cold Cranking Amps
Voltage	12 Volts

Power Train

Type	Hydrostatic (All Wheel Drive)
Hydrostatic Transaxle (2)	Hydro-Gear
Forward Speed* / Reverse Speed*7/4 mph (11/6.4 kph)
Brakes	Hydro-Dynamic
Hydraulic Oil Filtration	10 Micron

Controls & Instrument Panel

Steering	Power
PTO (Power Take Off)	Electric w/brake
Throttle Control	Cable
Directional Control	Speed, Direction, Lift, Auxiliary (SDLA)
Control Orientation	Hand / Foot
Gauges	Tachometer, Water Temperature, Hour Meter, Fuel, Speedometer
Parking/Emergency Brake	Disc

Other Features

Turning Radius	28 inches (71 cm)
Standard Tires	All Terrain (18 x 11-10) (46 x 28-26 cm)
Optional Tires	Turf (18 x 10.5-10) (46 x 27-26 cm)
Headlight	Halogen (55 watt)
Attachment System	Ventrac Mount

*May vary based on tire size, type, and inflation.

SPECIFICATIONS

Dimensions

Wheelbase38" (96.5 cm)
Overall Length76" (193 cm)
Overall Height (top of ROPS bar)72" (183 cm)
Overall Width*	40.5" (103 cm)
Weight**	1220 lbs.(553 kg)

Venture Products, Inc. reserves the right to change these specifications without notice.

*May vary based on tire size, type, and inflation.

**Weight varies based on setup (tires, optional accessories, etc.).

Fluid Capacities & Specifications

Fluid Type	Capacity	Filter	
Engine Oil	Synthetic 10W-30 [%]	3.9 quarts (3.7 liters)	13.0267
Hydraulic Oil (Front Transaxle & Reservoir)	HydroTorq XL Synthetic Hydraulic Oil	5.9 quarts (5.6 liters)	21.0124
Hydraulic Oil (Rear Transaxle)	HydroTorq XL Synthetic Hydraulic Oil	3 quarts (2.8 liters)	-
Cooling System	50% distilled water and 50% ethylene glycol antifreeze [^]	7 quarts (6.6 liters)	-
Fuel System	Ultra-Low Sulphur Diesel	5 gallons (18.9 liters)	13.0220
Grease	Lithium Complex NLGI #2	Refer to Maintenance Chart	-

[%] = use API Classification CI or higher

[^]Recommended antifreeze: a low silicate, phosphate free antifreeze (ethylene glycol) containing supplemental coolant additives (SCA's) to inhibit corrosion and rust.

Attention: Engine Oil Recommendation

For optimal engine life and performance, use Ventrac Full Synthetic Engine Oil.
Part # 15.0037-1



A copy of the parts manual and this operator's manual is available at:
<http://ventrac.com/manuals>



SPECIFICATIONS

Amperage Draw Chart

Stockcode	Component Description	3400Y	3400L
	Tractor (General Amp Draw)	4.9	1.2
	Fuel Pump	0.7	-
	Lights	4.8	4.8
37.0061	PTO Clutch	4.8	4.8

Options

70.3044	Work Light Kit	2.6	2.6
70.3045	Strobe Light Kit	0.2	0.2
70.3046	Directional / Hazard Signal Kit	1.1	1.1
70.3036	12 Volt Front Kit	Determined by Attachment	
70.3050	12 Volt Rear Kit	Determined by Attachment	
70.3037	Back-Up Alarm Kit	0.0	0.0

Weather Cab

70.2012	Weather Cab (Work Lights On, Windshield Wiper on High)	8.0	8.0
70.2012-51	Heater Kit (Fan on High)	8.5	-

Attachments

70.8025	12 Volt Actuator Kit (LX423 Snowblower)	0.8	0.8
23.0136-1	Directional Control Valve (KV550, KV552)	1.8	1.8
70.8035	Height Adjust Cylinder Kit (KR502, KR702)	3.6	3.6
39.55500	ES220 Spyker Spreader	8.0	8.0
70.2011	SS300 Salt Spreader	5.0	5.0
70.8134	SS300 Vibrator Kit	8.2	8.2

Belt Chart

Location	Belt Size	Ventrac Part Number
Engine Drive Belt	B64.5 Custom	81.0156
Front Transaxle Drive Belt	A41	81.A041
Rear Transaxle Drive Belt	A41	81.A041
PTO Drive Belt	B89	81.B089

WARRANTY



LIMITED WARRANTY - VENTRAC TURF EQUIPMENT

Venture Products, Inc. (shall be referred to as V.P.I.) warrants on the terms and conditions herein, that it will repair, replace, or adjust any part manufactured by Venture Products Inc. and found by Venture Products Inc. to be defective in material and / or workmanship.

Effective September 1st 2005, Ventrac warranty on power units & attachments (excluding the HG100/HG150 generator) for **residential use only** is limited to **three (3) years** from original purchase date. Ventrac power units & attachments used **commercially or for any income-producing purpose** is limited to **two (2) years** from original purchase date. Ventrac ET200 turbine blower (turbine only) is limited to **two (2) years** from original purchase date. Ventrac HG100/HG150 generator is limited to **one (1) year** from original purchase date. Ventrac power units & attachments used for **rental** is limited to **180 days** from original purchase date. (**NOTE:** All accessories such as: 3-point hitch, foot pedal, dual wheel kit, etc. will be covered under the above warranty periods as they would apply provided they are installed by an authorized Ventrac dealer.) This warranty may be transferred and will carry the remainder of the warranty starting from the original purchase/registration date with the dealership and/or V.P.I. In the event that product/s originally registered as **(3) year residential use** are to be transferred to a commercial user, the warranty would change to the remainder of **(2) year commercial use** starting from the original purchase/registration date with the dealership and/or V.P.I.

If this warranty covers a consumer product as defined by the Magnusson-Moss warranty act, no warranties, express or implied, (including, but not limited to, the warranty of merchantability or fitness for a particular purpose) shall extend beyond the applicable time period stated in bold face type above.

If this warranty covers a product used commercially or for any income producing purpose, the foregoing warranties are in lieu of all other warranties and no representations, guarantees or warranties, express or implied, (including, but not limited to, a warranty of merchantability or fitness for a particular purpose), are made by V.P.I. in connection with the manufacture or sale of its products.

The engine warranty is covered by its respective engine manufacturer. Please refer to the engine manufacturer's warranty statement that is included in the owner's manual.

The Ventrac turf equipment, including any defective parts, must be returned to an authorized Ventrac dealer within the warranty period. The warranty shall extend to the cost to repair or replace (as determined by V.P.I.) the defective part. **The expense of pickup and delivery of equipment, service call drive time or any transportation expense incurred for warranty repair is the sole responsibility of the owner and is not covered under warranty by Ventrac and/or V.P.I.** V.P.I.'s responsibility in respect to claims is limited to making the required repairs or replacements, and no claim of breach of warranty shall be cause for cancellation or rescission of the contract of sale of any Ventrac equipment. Proof of purchase may be required by the dealer to substantiate any warranty claim. Only warranty work performed and submitted by an authorized Ventrac dealer may be eligible for warranty credit.

This warranty extends only to Ventrac turf equipment operated under normal conditions and properly serviced and maintained. The warranty expressly does **not** cover: (a) any defects, damage or deterioration due to normal use, wear and tear, or exposure; (b) normal maintenance services, such as cleaning, lubrication, oil change; (c) replacement of service items, such as oil, lubricants, spark plugs, belts, rubber hoses or other items subject to normal service replacement; (d) damage or defects arising out of, or relating to abuse, misuse, neglect, alteration, negligence or accident; (e) repair or replacement arising from operation of, or use of the turf equipment which is not in accordance with operating instructions as specified in the operator's manual or other operational instructions provided by V.P.I.; (f) repair or replacement arising as a result of any operation from Ventrac turf equipment that has been altered or modified so as to, in the determination of V.P.I., adversely affect the operation, performance or durability of the equipment

WARRANTY



LIMITED WARRANTY - VENTRAC TURF EQUIPMENT

or that has altered, modified or affected the turf equipment so as to change the intended use of the product; (g) repair or replacement necessitated by the use of parts, accessories or supplies, including gasoline, oil or lubricants, incompatible with the turf equipment or other than as recommended in the operator's manual or other operational instructions provided by V.P.I.; (h) repairs or replacements resulting from parts or accessories which have adversely affected the operation, performance or durability of the turf equipment; or (i) damage or defects due to or arising out of repair of Ventrac turf equipment by person or persons other than an authorized Ventrac service dealer or the installation of parts other than genuine Ventrac parts or Ventrac recommended parts.

The sole liability of V.P.I. with respect to this warranty shall be repair and replacement as set forth herein. V.P.I. shall have no liability for any other cost, loss, or damage. In particular V.P.I. shall have no liability or responsibility for: (i) expenses relating to gasoline, oil, lubricants; (ii) loss, cost, or expense relating to transportation or delivery of turf equipment from the location of owner or location where used by owner to or from any authorized Ventrac dealer; (iii) travel time, overtime, after hours time or other extraordinary repair charges or charge relating to repairs or replacements outside of normal business hours at the place of business of an authorized Ventrac dealer; (iv) rental of like or similar replacement equipment during the period of any warranty repair or replacement work; (v) any telephone or telegram charges; (vi) loss or damage to person or property other than that covered by the terms of this warranty; (vii) any claims for lost revenue, lost profit or additional cost or expense incurred as a result of a claim of breach of warranty; or (viii) attorney's fees.

The remedies of buyer set forth herein are exclusive and are in lieu of all other remedies. The liability of V.P.I., whether in contract, tort, under any warranty, or otherwise, shall not extend beyond its obligation as set forth herein. V.P.I. shall not be liable for cost of removal or installation nor shall V.P.I. be responsible for any direct, indirect, special or consequential damages of any nature. In no event shall V.P.I. be liable for any sum in excess of the price received for the goods for which liability is claimed.

There are no representations or warranties which have been authorized to the buyer of the turf equipment other than set forth in this warranty. Any and all statements or representations made by any seller of this equipment, including those set forth in any sales literature or made orally by any sales representative, are superseded by the terms of this warranty. Any affirmation of fact or promise made by V.P.I. or any of its representatives to the buyer which relates to the goods that are the subject to this warranty shall not be regarded as part of the basis of the bargain and shall not be deemed to create any express warranty that such goods shall conform to the affirmation or promise.

No employee, distributor, or representative is authorized to change the foregoing warranties in any way or grant any other warranty on behalf of V.P.I.

Some states do not allow limitations on how long an implied warranty lasts or allow the exclusion on limitation of incidental or consequential damages, so the above limitation or exclusion may not apply to you.

This warranty gives you specific legal rights, and you may also have other rights which vary from state to state.

This warranty applies to all Ventrac turf equipment sold in the United States and Canada.